



GRAND SK

**SUPPLY
EQUIPMENT**

E-CATALOGUE

Contents

01. Shopping Bag

Shopping Bag	10
--------------	----

02. Bag

Bag	12
-----	----

03. Trash Bag

Trash Bag	16
-----------	----

04. Thermal Roll

Thermal Roll	18
--------------	----

05. Cup

Cup	20
-----	----

06. Container

Combo	23
-------	----

Special	29
---------	----

Body & Lid	32
------------	----

Sushi & Bento	36
---------------	----

07. Tray

Foam Tray	40
-----------	----

PP Tray	42
---------	----

Special Tray	47
--------------	----

Etc	50
-----	----

08. Bowl

Bowl	55
------	----

09. Wrap & Paper

Wrap & Paper	58
--------------	----

10. Clothes

H Mart Uniform	61
----------------	----

조리용	64
-----	----

방한복	67
-----	----

11. Boots

Boots	71
-------	----

12. Gloves

Gloves	73
--------	----

13. Chemicals

Chemicals	76
-----------	----

14. Freshener & Scrubber

Freshener & Scrubber	79
----------------------	----

15. Cleaning

Cleaning	81
----------	----

16. Dispenser

Towel & Refill	85
----------------	----

Handsoap & Refill	87
-------------------	----

우산 & 우산비닐 & 우산비닐 디스펜서	89
-----------------------	----

17. Label & Gun

Label & Gun	91
-------------	----

18. POP

POP	97
-----	----

청과과일 샐러드 POP	103
--------------	-----

19. Tape

Tape	106
------	-----

20. Decoration & Pad

Decoration & Pad	108
------------------	-----

21. Mat & Basket

Mat & Basket	110
--------------	-----

22. Dividing Supplies

Dividing Supplies	113
-------------------	-----

23. Fish Tools

Decoration & Pad	116
------------------	-----

24. Knives

Knives	119
--------	-----

25. Strings & Rubber Band

Strings & Rubber Band	122
-----------------------	-----

26. Scissors

Scissors	124
----------	-----

27. Utensil

Utensil	126
---------	-----

28. Restaurant Supply

Restaurant Supply	130
-------------------	-----

29. Equipment

Shopping Cart & Basket	136
------------------------	-----

Gondola & Rack	140
----------------	-----

Produce Bin & Orchard Bin	143
---------------------------	-----

Equipment Etc	145
---------------	-----

Electronic	150
------------	-----

30. Etc

Etc	153
-----	-----

NEW ITEM

OCTOBER 2024



GSK	95231093	GSK	91098044	GSK	95202016	GSK	95202017
166188/핸드페이퍼타올/TOWEL ROLL UNIVERSAL- 8x700' /white(6rl/cs)		B0BM9S3MBD/응급상처복합밴드 /RHINO RESCUE ZIP STITCH WITH WOUND DRESSINGS- 9.21x9.02x2.01" /white(6ea/cs)		30%할인레이블/R30% OFF ROUND LABEL- 2" /yellow(1000ea/rl)(25rl/cs)		50%할인레이블/R50% OFF ROUND LABEL- 2" /apricot(1000ea/rl)(25rl/cs)	
							
주문단위	CASE	입수량	6	주문단위	CASE	입수량	6
주문단위	CASE	입수량	6	주문단위	ROLL	입수량	1000
주문단위	CASE	입수량	6	주문단위	ROLL	입수량	1000
							
95231093		91098044		95202016		95202017	
GSK	95562190	GSK	95562191	GSK	95562209	GSK	95562210
NEW-전복3구/전복3구몸통 /ABALONE PLASTIC TRAY BODY- 9.44Wx4.3Lx0.87H" /pla/green(500ea/cs)		NEW-전복3구/전복3구뚜껑 /ABALONE PLASTIC TRAY LID- 9.44Wx4.3Lx0.5H" /pla/clear(500ea/cs)		LM-초밥34/초밥34호트레이몸통 /SUSHI TRAY BODY- 14.30Wx7.6Lx0.91H" /pla/gold(200ea/cs)		LM-초밥34/초밥34호트레이뚜껑 /SUSHI TRAY BODY- 14.50Wx7.8Lx1.18H" /pla/clear(200ea/cs)	
							
주문단위	CASE	입수량	500	주문단위	CASE	입수량	500
주문단위	CASE	입수량	500	주문단위	CASE	입수량	200
주문단위	CASE	입수량	500	주문단위	CASE	입수량	200
							
95562190		95562191		95562209		95562210	
GSK	99700001	GSK	95562215	GSK	95562216	GSK	95562217
SW-PMP/플라스틱자석프레임 /PLASTIC LETTER SIZE SIGN FRAME W/ MAGNET HOLDER- 8.5x11" /black(5ea/pk)		찜탕용기몸통(대)/HOT POT FOOD ROUND CONTAINER BODY LARGE- 14x4H" clear(100ea/cs)		찜탕용기은박접시(대)/HOT POT FOOD ROUND SILVER PAN LARGE- 12.5x2H" /silver(100ea/cs)		찜탕용기뚜껑(대)/HOT POT FOOD ROUND CONTAINER LID LARGE- 13.75" /clear(100ea/cs)	
							
주문단위	PACK	입수량	5	주문단위	CASE	입수량	100
주문단위	PACK	입수량	5	주문단위	CASE	입수량	100
주문단위	PACK	입수량	5	주문단위	CASE	입수량	100
							
99700001		95562215		95562216		95562217	

GSK	95562218	GSK	95562219	GSK	95562220	GSK	95562223
<p>찜탕용기몸통(중)/HOT POT FOOD ROUND CONTAINER BODY MEDIUM-13X4H"/clear(100ea./cs)</p>		<p>찜탕용기은박접시(중)/HOT POT FOOD ROUND SILVER PAN MEDIUM-11x2H"/silver(100ea./cs)</p>		<p>찜탕용기뚜껑(중)/HOT POT FOOD ROUND CONTAINER LID MEDIUM-12.4/clear(100ea./cs)</p>		<p>DR-PACK 37-3호(B)/초밥검척무늬몸통/SUSHI TRAY BODY-320Wx106Lx22H"/pla./black&red(200ea./cs)</p>	
							
주문단위	CASE	입수량	100	주문단위	CASE	입수량	100
							
95562218		95562219		95562220		95562223	
GSK	95562224	GSK	95562211	GSK	95562212	GSK	95562213
<p>DR-PACK 37-3호(C)/초밥검척무늬뚜껑/SUSHI TRAY LID-324Wx110Lx30H"/pla./clear(200ea./cs)</p>		<p>E-초밥17/초밥17호트레이몸통/SUSHI TRAY BODY-9.85Wx6.19Lx1.22H"/pla./red(300ea./cs)</p>		<p>E-초밥17/초밥17호트레이뚜껑/SUSHI TRAY LID-9.85Wx6.19Lx1.14H"/pla./clear(300ea./cs)</p>		<p>E-초밥21/초밥21호트레이몸통/SUSHI TRAY BODY-13.4Wx7.29Lx0.99H"/pla./gold(200ea./cs)</p>	
							
주문단위	CASE	입수량	200	주문단위	CASE	입수량	300
							
95562224		95562211		95562212		95562213	
GSK	95562214	GSK	95139006	GSK	95139007	GSK	95202008
<p>E-초밥21/초밥21호트레이뚜껑/SUSHI TRAY LID-13.6Wx7.48Lx0.99H"/pla./clear(200ea./cs)</p>		<p>TB-401-4/4구힌지과일컨테이너(소)/4PC HINGED FRUIT CONTAINER-8.46"x8.46"x4.63"/clear(250ea./cs)</p>		<p>TB-401-6/6구힌지과일컨테이너/6PC HINGED FRUIT CONTAINER-12.59"x8.86"x3.74"/clear(120ea./cs)</p>		<p>H-MART 40주년 기념 레이블/H-MART 40 YEARS ANNIVERSARY LABEL-2" DIA/red(1000ea./rl)</p>	
							
주문단위	CASE	입수량	200	주문단위	CASE	입수량	250
							
95562214		95139006		95139007		95202008	

GSK	95135006			GSK	95135007			GSK	99742000			GSK	99742001		
1구무스비용기/1PC MUSUBI CONTAINER 6.5x13x5cm/clear(400ea/cs)				EM-5호/1구삼각김밥용기/1PC TRIANGLE GIMBAP CONTAINER 11.5x11.5x4.5cm/clear(400ea/cs)				우영봉지/H-MART LOGO BURDOCK VENTED BAG-35.5" x 3.5"/clear(100ea/pk)				마봉지/H-MART LOGO CHINESE YAM VENTED BAG-31.5" x 6"/clear(100ea/pk)			
															
주문단위	CASE	입수량	400	주문단위	CASE	입수량	400	주문단위	PACK	입수량	100	주문단위	PACK	입수량	100
															
95135006				95135007				99742000				99742001			
GSK	95135003			GSK	95562200			GSK	95562230			GSK	95562201		
SD-414/4구한지과일컨테이너 /4PC HINGED FRUIT CONTAINER- 9.5"x9.5"x4"/clear(100ea/cs)				SSDY215/나무도시락/DIY WOODEN PASTRY CONTAINER W/WOODEN LID- 215x120x45mm/8.5x4.8x1.8"/small(100set/cs)				SSDY215/나무도시락이너케이스 /WOODEN PASTRY CONTAINER INNER- 215x120x45mm/8.5x4.8x1.8"/small /black(200ea/cs)				SSDY027/나무도시락/DIY WOODEN PASTRY CONTAINER W/WOODEN LID- 240x160x50mm/9.5x6.3x2"/large(100set/cs)			
															
주문단위	CASE	입수량	100	주문단위	CASE	입수량	100	주문단위	CASE	입수량	200	주문단위	CASE	입수량	100
															
95135003				95562200				95562230				95562201			
GSK	95562231			GSK	95562202			GSK	95562232						
SSDY027/나무도시락이너케이스 /WOODEN PASTRY CONTAINER INNER- 240x160x50mm/9.5x6.3x2"/large/black(200ea/cs)				SSDY200/나무도시락/DIY WOODEN PASTRY CONTAINER W/WOODEN LID- 200x200x50mm/7.9x7.9x2"/square(100set/cs)				SSDY200/나무도시락이너케이스 /WOODEN PASTRY CONTAINER INNER- 200x200x50mm/7.9x7.9x2"/square /black(200ea/cs)							
															
주문단위	CASE	입수량	200	주문단위	CASE	입수량	100	주문단위	CASE	입수량	200				
															
95562231				95562202				95562232							

A vibrant autumn-themed poster for an inventory sale. The background features a soft pink and yellow sky with falling leaves and a lighthouse on the left. In the foreground, a couple is dancing on a purple path surrounded by large piles of golden leaves. The text is prominently displayed in the center.

INVENTORY BLOWOUT SALE

OCTOBER 2024







GSK	91000013			GSK	91000014			GSK	95138148			GSK	95170317		
2050HFA/알루미늄풀사이즈뚜껑 /ALUMINUM LID FOR FULL SIZE STEAM TABLE(50ea/cs)				2049HFA/알루미늄중간사이즈뚜껑 /ALUMINUM LID FOR HALF SIZE STEAM TABLE(100ea/cs)				SR9048W/화이트전자레인지용냉 동원형용기/WHITE MICROWAVABLE ROUND CONTAINER- 9"/48oz/rgr(150ea/cs)				MT-25S-CL/플라스틱 트레이 /PETE TRAY-14-3/4"x8"x1",25s clear(200ea/cs)			
															
주문단위	CASE	입수량	50	주문단위	CASE	입수량	100	주문단위	CASE	입수량	150	주문단위	CASE	입수량	200
															
91000013				91000014				95138148				95170317			

GSK	96340343			GSK	96900051			GSK	96900122			GSK	96900123		
ISK그리드월8인치더블훅/ ISK GRIDWALL DOUBLE HOOK- 8"(100ea/cs)				TBS106573/POP블랙프라이스타그 /POP SLANTED PRICE TAG FOR PRODUCE- 48"Lx1.5"Hx0.5T"(50ea/cs)				CIR/가격태그/CHANNEL TAG INSERT PRICE-(100ea/pk)				B3220057/채널태그클립프레임 /CHANNEL TAG LONG CLIP-4 1/2"x2 1/2"/(15ea/pk)			
															
주문단위	CASE	입수량	100	주문단위	CASE	입수량	50	주문단위	PACK	입수량	100	주문단위	PACK	입수량	1
															
96340343				96900051				96900122				96900123			

GSK	96900201			GSK	96340113		
3색포켓프레임/3 COLOR POCKET FRAMES WITH ADAPTER- (20ea/pk)				159850/진열대칸막이/CLEAR CASE DIVIDER WITH RED TIP- 3"x30"			
							
주문단위	PACK	입수량	20	주문단위	EACH	입수량	1
							
96900201				96340113			

SHOPPING BAG

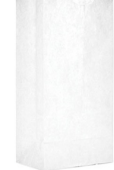

GSK	95104025	GSK	93231493	GSK	93231494	GSK	93231495
H-MART 쇼핑백/H-MART PLASTIC SHOPPING BAG-12x7x20.75"/hdpe/16.5mic/15.21lb(1000ea/cs)		H-MART로고친환경쇼핑백/H-MART LOGO REUSEABLE SHOPPING BAG-43x40cm/white&black logo(100ea/cs) *73231493*		H-MART로고친환경쇼핑백/VALUE GROCERY TOTE BAG-43x40cm/white&red logo(100ea/cs) *73231494*		H-MART로고친환경쇼핑백(검정손잡이)/H-MART LOGO REUSABLE SHOPPING BAG-35x40cm/white&red logo(100ea/cs) *73231495*	
							
주문단위	CASE	입수량	1000	주문단위	CASE	입수량	100
							
95104025		93231493		93231494		93231495	
GSK	93231496	GSK	93231510	GSK	95944280	IMPERIAL	85104050
H-MART I LOVE SEOUL 친환경쇼핑백/I LOVE SEOUL REUSABLE SHOPPING BAG(100ea/cs) *73231496*		H-MART JUST LET ME SHOP/친환경 보온보냉 쇼핑백/THERMO REUSABLE SHOPPING BAG-35x40cm/orange(50ea/cs) *73231510*		친환경쇼핑백/REUSABLE BAG W/ HANDLE-12.5Wx13.75Hx7L"/red(100ea/cs)		QUIKSAK/전자부용쇼핑백(M)/THANK YOU SHOPPING BAG-11.5x6.5x21"(1000ea/cs)	
							
주문단위	CASE	입수량	100	주문단위	CASE	입수량	100
							
93231496		93231510		95944280		85104050	
IMPERIAL	85104030	IMPERIAL	85104070	IMPERIAL	85109007	GSK	95104062
16830SAK/전자부용쇼핑백(L)/WHITE SHOPPING BAG/15x7x27"(500ea/cs)		SAKBEIGE/브라운쇼핑백/BEIGE SHOPPING BAG-11-1/2x6-1/2x21"(600ea/cs)		6WSOB/페이퍼백/WHITE 6LB PAPER BAG/6x3-5 8x11 1/16"(500ea/cs)		H-MART 종이쇼핑백/H-MART PAPER NATURAL KRAFT BAG-12X17X7"/85gsm/(500ea/cs)	
							
주문단위	CASE	입수량	500	주문단위	CASE	입수량	600
							
85104030		85104070		85109007		95104062	

IMPERIAL	85109005			IMPERIAL	85109010			IMPERIAL	85109006			IMPERIAL	85109029		
1/6/50/페이퍼백/BAG PAPER SACK AJM NATUAL1/6 BBL 52# GROCERY BAGS- 11.81x7x17"(500ea/cs)				VB1852S/브라운페이퍼백 /1/8/50 BROWN PAPER BAG- 10x6-3/4x14 1/2"(500ea/cs)				6SOB/브라운페이퍼백/BROWN 6LB PAPER BAG-6x3-5/8x11- 1/16"(500ea/cs)				8SOB/브라운종이백/8LB KRAFT BAY BROWN BAG- 6"x4"x12.5"(500ea/cs)			
															
주문단위	CASE	입수량	500	주문단위	CASE	입수량	500	주문단위	CASE	입수량	500	주문단위	CASE	입수량	500
															
85109005				85109010				85109006				95109029			









IMPERIAL	85109019			IMPERIAL	85109011		
20HV400/페이퍼백/PAPER BAG HEAVY DUTY- 8"x5.5"x16"/20lb/brown(400ea/cs)				72609/#65페이퍼백/BEER KRAFT EXTRA HEAVY PAPER BAG- 25lb/8.25"x5 15/16"x15 7/8"(300ea/pk)			
							
주문단위	CASE	입수량	400	주문단위	PACK	입수량	300
							
85109019				85109011			

BAG



GSK	95101191	GSK	95101192	GSK	95101005	GSK	95101200								
스탠드형롤백디스펜서/STAND TYPE ROLL BAG DISPENSER		설치형롤백디스펜서/ATTACHED TYPE ROLL BAG DISPENSER		HMART 122012/H-MART로고롤백 /H-MART LOGO ROLL BAG—small/12mic/12x20”(1000ea/4rl/cs)		PSHMART 1824/H-MART 배추롤백 /H-MART LOGO PRODUCE ROLL BAG—LARGE/18x24”(4rl/cs)									
															
주문단위	EACH	입수량	1	주문단위	EACH	입수량	1	주문단위	CASE	입수량	4	주문단위	CASE	입수량	4
															
95101191		95101192		95101005		95101200									
IMPERIAL	85101150	IMPERIAL	85103006	IMPERIAL	85104090	GSK	95108010								
RP15HD/로고없는야채롤백(특소)PRODUCE ROLL BAG/10x15”(4rl/cs)		FB6315R/야채폴리백/CLEAR POLY BAG—6x3x15”—clear(1000ea/cs)		18PTB/스시플래터백/CARRY BAG FOR CATERING PLATTER—18”(50ea/cs)		GRAPENET/그물망백/VEXAR MESH BAG—green/15”(1000ea/cs)									
															
주문단위	CASE	입수량	4	주문단위	CASE	입수량	1000	주문단위	CASE	입수량	50	주문단위	CASE	입수량	1000
															
85101150		85103006		85104090		95108010									
IMPERIAL	85108052	GSK	95108020	IMPERIAL	85108053	IMPERIAL	85108050								
AHL5.5X20G/그물망백/VEXAR MESH BAG—18”/green/(1000ea/cs)		GRAPENET/그물망백/VEXAR MESH BAG—15”/red(1000ea/cs)		AHL5.5X20R/그물망백/VEXAR MESH BAG—18”/red(1000ea/cs)		HBR1245/그물망백/VEXAR MESH BAG—23”/orange/(1000ea/cs)									
															
주문단위	CASE	입수량	1000	주문단위	CASE	입수량	1000	주문단위	CASE	입수량	1000	주문단위	CASE	입수량	1000
															
85108052		95108020		85108053		85108050									

IMPERIAL	85109032	IMPERIAL	85109033	GSK	99742000	GSK	99742001
10X16CRY/숨쉬는야채백/VENTED FILM BAG-10x16"(1000ea/cs)		11X20CRY/숨쉬는야채백/VENTED FILM BAG-11x20"(1000ea/cs)		우영봉지/H-MART LOGO BURDOCK VENTED BAG-35.5" x 3.5"/clear(100ea/pk)		마봉지/H-MART LOGO CHINESE YAM VENTED BAG-31.5" x 6"/clear(100ea/pk)	
							
주문단위	CASE	입수량	1000	주문단위	CASE	입수량	1000
							
85109032		85109033		99742000		99742001	

GSK	95101137	GSK	95101138	GSK	95101242	GSK	95101243
C14V/구멍난상추폴리백/8.8lb VENTED POLY BAG CLEAR/LETTUCE-8x4x14"(1000ea/cs)		C18V/구멍난폴리백/VENTED CLEAR PER FOR ATED POLY BAG/8x4x18"(1000ea/cs)		11162/#12야사이폴리백/#12 YASAI POLY BAG-9x13.5"/1mil/clear(1000ea/cs)		11161/#13야사이폴리백/#13 YASAI POLY BAG/10.25x17"/1mil/clear(1000ea/cs)	
							
주문단위	CASE	입수량	1000	주문단위	CASE	입수량	1000
							
95101137		95101138		95101242		95101243	

GSK	95101202	GSK	95101201	GSK	95101203	GSK	95101205
ZIP-106.5-CLEAR/청과부구멍난지퍼백(소)/VENTED ZIPPER POUCH BAG WITH HANDLE-SMALL-10"x6.5"(500ea/cs)		ZIP-109-CLEAR/청과부구멍난지퍼백(중)/VENTED ZIPPER POUCH BAG WITH HANDLE-MID-10"x9"(500ea/cs)		ZIP-1012-CLEAR/청과부구멍난지퍼백(대)/VENTED ZIPPER POUCH BAG WITH HANDLE-BIG-10"x12"(500ea/cs)		PP-6484-CLEAR/투명토드백/SOFT LOOP HANDLE CLEAR BAG-6.75"x8.5"(200ea/cs)	
							
주문단위	CASE	입수량	500	주문단위	CASE	입수량	500
							
95101202		95101201		95101203		95101205	

GSK	95101204	GSK	95102030	GSK	91010001	GSK	95103110
PHB-SEAFOOD-LRG/수산부폴리백/LOBSTER LOGO SEAFOOD BAG-12x18"/large(1000ea/cs)		PVGR/그물형포도백/VENTED GRAPE BAG EXTRA HEAVY(1000ea/cs)		442RCHH12154/투명지퍼백/4 MIL ZIPPER POUCH BAG -12" x 15"/clear(500ea/cs)		C18H/폴리백/10.8lb POLY BAG/clear-8x4x18"(1000ea/cs)	
							
주문단위	CASE	입수량	1000	주문단위	CASE	입수량	1000
							
95101204		95102030		91010001		95103110	
GSK	95103190	GSK	95103120	GSK	95103130	GSK	95103150
C18XH/더블엑스트라헤비폴리백/2XL HEAVY POLY BAG-clear/8x4x18"/17.20lb(1000ea/cs)		C24XH/폴리백/POLY BAG-clear/10x8x24"/17.2LB(500ea/cs)		C30H/폴리백/XTRA HEAVY POLY BAG-clear/12"x8"x30"/20lb(250ea/2pk/cs)		C1218XH/폴리백/KIMCHI XHVY POLY BAG-12x18"/clear(1000ea/cs)	
							
주문단위	CASE	입수량	1000	주문단위	CASE	입수량	500
주문단위	CASE	입수량	1000	주문단위	CASE	입수량	250
주문단위	CASE	입수량	1000	주문단위	CASE	입수량	1000
							
95103190		95103120		95103130		95103150	
IMPERIAL	85103140	GSK	95102032	IMPERIAL	85542001	GSK	95401001
108DELI/델리백/DELI BAG-10x8"(1000ea/cs)		BOBEGB/포도그림포도백/GRAPE DESIGN VENTED GRAPE BAG-10.25x11x5.25"(1000ea/cs)		321602/햄버거봉투/FOIL LAMINATED BAG HAMBURGER-6Wx6.75L"(1000ea/cs)		S-10868/폴리백(수산부용)/1 ML POLY BAG-5x24"/clear(1000ea/cs)	
							
주문단위	CASE	입수량	1000	주문단위	CASE	입수량	1000
주문단위	CASE	입수량	1000	주문단위	CASE	입수량	1000
주문단위	CASE	입수량	1000	주문단위	CASE	입수량	1000
							
85103140		95102032		85542001		95401001	

GSK	91060001
-----	----------

B07H513XJZ / 꽃다발 포장봉투 / A&A FLOWER BOUQUET UNPRINTED PLASTIC BAG— 37micron / 9x14x3.5" / clear (100ea / cs)	
--	--











주문단위	CASE	입수량	100
------	------	-----	-----



TRASH BAG



IMPERIAL		85505003		GSK		92005001		GSK		92005002		IMPERIAL		85505001	
VBLH3858115B / 검정쓰레기백 / VICTORIA BAY CAN LINER— 38x58" / 60gal, 1.15mil / black (100 / cs)				(동부용)RH3660022C / HDPE레쿨러 반투명쓰레기백 / HDPE GABAGE BAG— 36" x 60" / 22mic / 22eq / 55gal / white (100ea / cs)				(동부용)ELJ386012C / 헤비클리어쓰 레기백 / LDPE XTRA HEAVY DUTY GABAGE BAG— 38" x 58" / 1.0mil / 55gal / white (100ea / cs)				R3037N12 / 20-30gal / 클리어쓰레 기백 / VB CAN LINER NAT— 30x37" (500ea / cs)			
															
주문단위	CASE	입수량	100	주문단위	CASE	입수량	100	주문단위	CASE	입수량	100	주문단위	CASE	입수량	500
															
85505003				92005001				92005002				85505001			

THERMAL ROLL



GSK		95231908		IMPERIAL		85231918		IMPERIAL		85231920		IMPERIAL		85231921	
HMART계산부영수증롤/THERMAL REGISTER TAPE ROLL,3-1/8x279',BPA FREE/55GSM,(50rl/cs)				225085T/영수증롤/REGISTER ROLL FOR RESTAURANTS-2 1/4x85"(50rl/cs)				30095C/2겹영수증롤/REGISTER ROLL FOR RESTAURANT-3"(50rl/cs)				13585/영수증롤/REGISTER ROLL FO RESTAURANT-2 1/4x50'(50rl/cs)			
															
주문단위	CASE	입수량	50	주문단위	CASE	입수량	50	주문단위	CASE	입수량	50	주문단위	CASE	입수량	50
															
95231908				85231918				85231920				85231921			

CUP



IMPERIAL	85121309	IMPERIAL	85121311	IMPERIAL	85121312	GSK	95121304								
8HDCF/종이컵/PAPER HOT CUP-8oz(1000ea/cs)		10HDCF/100Z종이컵/PAPER HOT CUP(1000ea/cs)		12HDCCF/종이컵/PAPER HOT CUP-12oz(1000ea/cs)		400F/샘플 종이컵/GENPAK PAPER SAMPLE CUP-4oz/(2500ea/cs)									
															
주문단위	CASE	입수량	1000	주문단위	CASE	입수량	1000	주문단위	CASE	입수량	1000	주문단위	CASE	입수량	2500
															
85121309		85121311		85121312		95121304									
GSK	95221144	IMPERIAL	85121203	IMPERIAL	85121206	IMPERIAL	85121208								
350410/W4FC/꼬깔 종이컵/PAPER CONE CUP-4oz(5000ea/cs)		4J4/폼컵/FOAM CUP-4oz(1000ea/cs)		6J6/폼컵/FOAM CUP-6oz/(1000ea/cs)		8J8/폼컵/FOAM CUP UPD DART/8oz/(1000ea/cs)									
															
주문단위	CASE	입수량	5000	주문단위	CASE	입수량	1000	주문단위	CASE	입수량	1000	주문단위	CASE	입수량	1000
															
95221144		85121203		85121206		85121208									
IMPERIAL	85122208	IMPERIAL	85139016	IMPERIAL	85139017	IMPERIAL	85121107								
8SJ20/폼보울FOAM BOWL WHITE/DART/SQUAT-8oz.(1000ea/cs)		16MJ20/폼컵/MED SQUAT FOAM CONTAINER-16oz(1000ea/cs)		20JL/폼컵뚜껑/LID FOR MED SQUAT FOAM CONTAINER-16oz(1000ea/cs)		VBPCP1C/1온즈플라스틱샘플링컵/VICTORIA BAY SOUFFLE PORTION CUP-1oz(2500ea/cs)									
															
주문단위	CASE	입수량	1000	주문단위	CASE	입수량	1000	주문단위	CASE	입수량	1000	주문단위	CASE	입수량	2500
															
85122208		85139016		85139017		85121107									







GSK	95121152			GSK	95121153			GSK	95121154			GSK	95121155		
352012 / 플라스틱 샘플링 컵 / PLASTIC PORTION CUP - 2oz (2500ea / cs)				352013 / 플라스틱 샘플링 컵 뚜껑 / LID FOR PLASTIC PORTION CUP - 2oz (2500ea / cs)				352016 / 플라스틱 샘플링 컵 / PLASTIC PORTION CUP - 4oz (2500ea / cs)				352015 / 플라스틱 샘플링 컵 뚜껑 / LID FOR PLASTIC PORTION CUP - 4oz (2500ea / cs)			
															
주문단위	CASE	입수량	2500	주문단위	CASE	입수량	2500	주문단위	CASE	입수량	2500	주문단위	CASE	입수량	2500
															
95121152				95121153				95121154				95121155			





IMPERIAL	85121117			IMPERIAL	85521013		
VBPP5CUP / 플라스틱 콜드 컵 / VICTORIA BAY PLASTIC COLD CUP - 5oz / clear (2500ea / cs)				VBPP7CUP / 투명 플라스틱 컵 / CLEAR PLASTIC CUP - 7oz (2500ea / cs)			
							
주문단위	CASE	입수량	2500	주문단위	CASE	입수량	2500
							
85121117				85521013			

CONTAINER

- COMBO



























GSK	95135008	GSK	95135012	GSK	95135016	GSK	95135020
TS8/밀폐사각힌지용기/TAMPER RESIST RECTANGLE CONTAINER-8oz/clear(240ea/cs)		TS12/밀폐사각힌지용기/TAMPER RESIST RECTANGLE CONTAINER-12oz/clear(240ea/cs)		TS16/밀폐사각힌지용기/TAMPER RESIST RECTANGLE CONTAINER-16oz/clear(240ea/cs)		TS20/밀폐사각힌지용기/TAMPER RESIST RECTANGLE CONTAINER-20oz/clear/hinged(200ea/cs)	
							
주문단위	CASE	입수량	240	주문단위	CASE	입수량	240
							
95135008		95135012		85136016		95135020	
GSK	95135024	GSK	95135032	GSK	95135048	GSK	95135064
TS24/밀폐사각힌지용기/TAMPER RESIST RECTANGLE CONTAINER-24oz/clear/hinged(200ea/cs)		TS32/밀폐사각힌지용기/TAMPER RESIST RECTANGLE CONTAINER-32oz/clear/hinged(200ea/cs)		TS48/밀폐사각힌지용기/TAMPER RESIST RECTANGLE CONTAINER-48oz/clear/hinged(150ea/cs)		TS64/밀폐사각힌지용기/TAMPER RESIST RECTANGLE CONTAINER-64oz/clear/hinged(150ea/cs)	
							
주문단위	CASE	입수량	200	주문단위	CASE	입수량	200
							
95135024		95135032		95135048		95135064	
IMPERIAL	85132115	IMPERIAL	85535001	IMPERIAL	85132124	IMPERIAL	85132125
ADO6/사각힌지용기/RECTANGLE CONTAINER CLEAR/HINGE-6oz(400ea/cs)		D751601B/사각 힌지 용기/HINGED SHALLOW LID RECTANGLE CONTAINER-16oz/clear(200ea/cs)		AD24F/사각힌지용기/RECTANGLE CONTAINER HINGED DOME LID-24oz/clear(200ea/cs)		D752401/사각힌지용기/CONT HINGED DELI/24oz/clear(200ea/cs)	
							
주문단위	CASE	입수량	400	주문단위	CASE	입수량	200
							
85132115		85535001		85132124		85132125	

IMPERIAL	85136006	IMPERIAL	85132132	IMPERIAL	85132148	IMPERIAL	85132149
04S24/정사각형투명용기몸통 /SQUARE BOWL- 24oz/clearLid:04SFL(500ea/cs)		AD32F/사각힌지용기/RECTANGLE CONTAINER HINGED DOME LID/32oz/clear(200ea/cs)		AD48/델리힌지사각컨테이너 /HINGED DELI DOME CONTAINER- 48oz(200ea/cs)		D754801/사각힌지용기/DARNEL CLEAR SELLO PLUS CONTAINER W/SHALLOW LID-48oz(200ea/cs)	
							
주문단위	CASE	입수량	500	주문단위	CASE	입수량	200
							
85136006		85132132		85132148		95132149	

IMPERIAL	85132164	IMPERIAL	85134092	IMPERIAL	85132017	IMPERIAL	85132018
AD64/사각힌지용기/RECTANGLE CONTAINER-64oz(200ea/cs)		C95PST1/사각샐러드힌지 용기 /RECTANGLE SALAD CONTAINER- 9x9-1/2x3"(200ea/cs)		SLP17XD/사각힌지용기 /RECTANGLE CONTAINER-7 1/4x4 7/16x2 9/16/clear(400ea/cs) 1구 랍스터 틀용		SL18/스시베이질컨테이너사각힌 지용기/RECTANGLE CONTAINER-8 1/2"x4 7/16"x1 7/8"/clear/(300ea/cs)	
							
주문단위	CASE	입수량	200	주문단위	CASE	입수량	400
							
85132164		85134092		85132017		85132018	

IMPERIAL	85132060	IMPERIAL	85132061	IMPERIAL	85132065	IMPERIAL	85132067
LBH615,LBH615R/힌지사각컨테이 너/HINGED PLASTIC CONTAINER- 9x6 1/2x2"/clear/hinged(350ea/cs)		LBH661/힌지사각컨테이너 /HINGED PLASTIC CONTAINER-9 3/8x6 3/4x1 13/16"(350ea/cs)		LBH665/힌지사각컨테이너 /HINGED PLASTIC CONTAINER-9 3/8x6 3/4x3" (350ea/cs)		LBH667/사각힌지용기 /RECTANGLE CONTAINER-9 3/8"x6 3/4"x2 1/4"/clear(350ea/cs)	
							
주문단위	CASE	입수량	350	주문단위	CASE	입수량	350
							
85132060		85132061		85132065		85132067	

IMPERIAL	85132049	IMPERIAL	85134066	IMPERIAL	81000037	IMPERIAL	85134090
LBH491R/힌지사각컨테이너 /HINGED(DAE CHOO) CONTAINER/7 3/8x4 13/16x3 3/16"/clear/hinged(300ea/cs)		YC81160/사각샐러드힌지용기 /RECTANGLE SALAD CONTAINER- 5 3/4"x6"x3"/clear(500ea/cs)		C57PST1/사각샐러드힌지 용기 /RECTANGLE SALAD CONTAINER- 6x5-13/16"x3"(500ea/cs)		C90PST1/사각샐러드힌지용기 /RECTANGLE SALAD CONTAINER/8 5/16"x8 5/16"x3"/clear(250ea/cs)	
							
주문단위	CASE	입수량	300	주문단위	CASE	입수량	500
							
85132049		85134066		81000037		85134090	
IMPERIAL	85139105	IMPERIAL	85139112	IMPERIAL	85139104	IMPERIAL	85139115
50HT1/힌지폼컨테이너햄버거 /HINGED FOAM BURGER CONTAINER-5"x5"(500ea/cs)		60HT1/1등분사각폼용기/HINGED SQUARE FOAM CONTAINER- 6x6x3"/white(500ea/cs)		HL205/힌지폼컨테이너/HINGED FOAM, 205HT1, HL205- 6x9x3"(200ea/cs)		80HT1R/SN220/1등분사각폼용기 /RECTANGLE HINGED FOAM CONTAINER-8-7/16"x7- 5/8"x2-3/8"/white(200ea/cs)	
							
주문단위	CASE	입수량	500	주문단위	CASE	입수량	200
							
85139105		95139112		85139104		85139115	
IMPERIAL	85139113	IMPERIAL	85139106	IMPERIAL	85139111	IMPERIAL	85132046
85HT1/1등분사각폼용기/HINGED SQUARE FOAM CONTAINER- 8"x8"x3"/white(200ea/cs)		95HT3/직원용도시락3등분용기 /DART 3 COMPT LARGE FOAM HINGED CONTAINER-9"(200ea/cs)		85HT3/3등분사각폼용기/SQUARE FOAM CONTAINER- 8x8x3"/white(200ea/cs)		LBH463/힌지 사각 컨테이너 /HINGED HOAGE TRAY DF- 8.5X4.5X3.5(500ea/cs)	
							
주문단위	CASE	입수량	200	주문단위	CASE	입수량	200
							
85139113		85139106		95139111		85132046	

IMPERIAL	85136012	IMPERIAL	85136016	GSK	95136017	IMPERIAL	85136024								
TS12R/밀폐원형힌지용기(돌형뚜껑)/TAMPER RESISTANT HINGED CONTAINER-12oz(240ea/cs)		TS16R/밀폐 원형힌지용기 /TAMPER RESIST ROUND CONTAINER-16OZ-DOME LID(240ea/cs)		TS16RS/밀폐원형힌지용기 /TAMPER RESIST ROUND CONTAINER-16OZ-FLAT LID(240ea/cs)		TS24R/밀폐원형힌지용기 /TAMPER RESIST ROUND CONTAINER-24OZ-DOME LID(150ea/cs)									
															
주문단위	CASE	입수량	240	주문단위	CASE	입수량	240	주문단위	CASE	입수량	240	주문단위	CASE	입수량	150
															
85136012		85136016		95136017		85136024									
IMPERIAL	85136032	IMPERIAL	85135051	IMPERIAL	85135068	GSK	95135365								
TS32R/밀폐원형힌지용기/DOME LID TAMPER RESIST ROUND CONTAINER-32oz(150ea/cs)		TS48RN/밀폐원형힌지용기/DOME LID TAMPER RESIST ROUND CONTAINER-48oz(100ea/cs)		TS64RN/밀폐원형힌지용기 /TAMPER RESIST CLAMSHELL CONTAINER-64OZ-CLEAR/HINGED(100ea/cs)		CFS64RB/장미무늬용기콤보 /CLEAR ROSEWARE COMBO BOWL AND LID-64oz(100ea/cs)									
															
주문단위	CASE	입수량	150	주문단위	CASE	입수량	100	주문단위	CASE	입수량	100	주문단위	CASE	입수량	100
															
85136032		85135051		95135068		95135365									
IMPERIAL	85137624	IMPERIAL	95132015	GSK	95138216	GSK	95138232								
PET24BCD/원형용기콤보/ ROUND CLR PRESENTA COMBO- 24oz(126ea/cs)		TS1SW/삼각샌드위치힌지컨테이너/TAMPER EVIDENT& TAMPER RESISTANT CLAMSHELL SANDWICH WEDGE 17OZ- 7.312x4.125x3.625"(288ea/cs)		FT-S16/원형용기콤보 /MICROWAVABLE DELI SOUP CONTAINER- 16oz/translucent(240ea/cs)		FT-S32/원형용기콤보 /MICROWAVABLE DELI SOUP CONTAINER- 32oz/translucent(240ea/cs)									
															
주문단위	CASE	입수량	126	주문단위	CASE	입수량	288	주문단위	CASE	입수량	240	주문단위	CASE	입수량	240
															
85137624		95132015		95138216		95138232									

IMPERIAL	85135013	IMPERIAL	85135014	GSK	91035008	GSK	95139005
TS16CCR/원형힌지플라스틱컵플랫리드/ROUND HINGED PLASTIC CUP W/ FLAT LID-16oz/4.38"x4.45"x4.45"(232ea/cs)		TS16CCRD/원형힌지플라스틱컵돔리드/ROUND HINGED PLASTIC CUP W/ DOME LID-16oz/4.38"x4.45"x5.45"(232ea/cs)		675SW5000T/투고용투명컨테이너/TAMPER-RESISTANT CLEAR TAKEOUT HINGED CONTAINER-9Lx5Wx3H"/clear(100ea/cs)		SD214/3구힌지과일컨테이너/3PC HINGED FRUIT CONTAINER-clear(300ea/cs)	
							
주문단위	CASE	입수량	232	주문단위	CASE	입수량	300
							
85135013		85135014		91035008		95139005	
GSK	95135003	IMPERIAL	85735004	GSK	95132017	GSK	95735003
SD-414/4구힌지과일컨테이너/4PC HINGED FRUIT CONTAINER-9.5"x9.5"x4"/clear(100ea/cs)		TS202/돔리드힌지컨테이너/CLAMSHELL HINGED CONTAINER 40OZ WITH DOME LID-8Wx3Hx3L"/clear(150ea/cs) 랍스터를 TX용		SLP17XD/사각힌지용기/RECTANGLE CONTAINER-7 1/4"x4 7/16"x2 9/16"/clear(400ea/cs)		SC5130FS/랍스터롤2구컨테이너/FULL SHELF SLICED LOAF CONTAINER-7.7x6.75x2.375"(160ea/cs)	
							
주문단위	CASE	입수량	100	주문단위	CASE	입수량	160
							
95135003		85735004		95132017		95735003	
GSK	95135006	GSK	95135007	GSK	95139006	GSK	95139007
1구무스비용기/1PC MUSUBI CONTAINER 6.5x13x5cm/clear(400ea/cs)		EM-5호/1구삼각김밥용기/1PC TRIANGLE GIMBAP CONTAINER 11.5x11.5x4.5cm/clear(400ea/cs)		TB-401-4/4구힌지과일컨테이너(소)/4PC HINGED FRUIT CONTAINER-8.46"x8.46"x4.63"/clear(250ea/cs)		TB-401-6/6구힌지과일컨테이너/6PC HINGED FRUIT CONTAINER-12.59"x8.86"x3.74"/clear(120ea/cs)	
							
주문단위	CASE	입수량	400	주문단위	CASE	입수량	120
							
95135006		95135007		95139006		95139007	

CONTAINER

- SPECIAL



IMPERIAL	85137533	GSK	95138028	GSK	95138031	IMPERIAL	85135160
KT8316K/사각냉동용기꺾보 /MICROWVBLE CONTAINER- 16oz/black(150ea/cs)		SR868B/블랙전자레인지용냉동사 각용기/BLACK MICROWAVABLE RECT CONTAINER- 8"x6"/28oz/shallow(150ea/cs)		SR-28B/블랙전자레인지용냉동사 각용기/BLACK MICROWAVABLE 2 COMP RECT CONTAINER- 8"x6"/28oz(150ea/cs)		8288B/떡볶이순대용기/2COMP BLACK OBLONG W/DOME LID- 28oz(150ea/cs)	
							
주문단위	CASE	입수량	150	주문단위	CASE	입수량	150
							
85137533		95138028		95138031		85135160	
IMPERIAL	85535022	GSK	95138030	IMPERIAL	85535021	GSK	95138029
VBNRE32-2/2구뚜고용기 /RECTANGLE 2 COMPARTMENT COMBO MICROWAVE SAFE- 32oz/black(150ea/cs)		SR8288B/블랙전자레인지용2등분 냉동사각용기/BLACK MICROWAVABLE 2 COMP RECT CONTAINER- 8"x6"/32oz(150ea/cs)		MT3350B/3등분사각컨테이너 /RECTANGLE THREE COMPARTMENT CONTAINER w/LID COMBO-32oz/black(150ea/cs)		SR868W/화이트전자레인지용냉동 사각용기/WHITE MICROWAVABLE RECT CONTAINER- 8"x6"/28oz/shallow(150ea/cs)	
							
주문단위	CASE	입수량	150	주문단위	CASE	입수량	150
							
85535022		95138030		85535021		95138029	
IMPERIAL	85535024	GSK	95221116	GSK	95138124	GSK	95138132
SR9388B/3등분원형컨테이너 /ROUND PLASTIC 3 COMPARTMENT CONTAINER & LID COMBO-39oz/black(150ea/cs)		NC718B/전자레인지용냉동원형용 기/CONTAINER VERS- 16oz/black/round(150ea/cs)		SR-723B/블랙전자레인지용냉동 원형용기/BLACK MICROWAVABLE ROUND CONTAINER- 7.25x2.25"/24oz/shallow(150ea/cs)		SR-729B/블랙전자레인지용냉동 원형용기/BLACK MICROWAVABLE ROUND CONTAINER- 7.25x2.75"/32oz/deep(150ea/cs)	
							
주문단위	CASE	입수량	150	주문단위	CASE	입수량	150
							
85535024		95221116		95138124		95138132	

IMPERIAL	85137548			GSK	95138148			IMPERIAL	85135139			IMPERIAL	85535018		
948B/방동원형블랙용기콤보 /BLACK ROUND MICROWABLE W/DOME LID-48oz(150ea/cs)				SR9048W/화이트전자레인지용방 동원형용기/WHITE MICROWAVABLE ROUND CONTAINER- 9"/48oz/rgr(150ea/cs)				CNC10700DZY/돔리드투고용기 /RECTANGLE HALF SLAB RIB CONTAINER AND CLEAR DOME LID COMBO- 10Lx7Wx2H"/black&clear(90ea/cs)				YCNC167000DZ/돔리드투고용기 /RECTANGLE FULL SLAB RIB CONTAINER AND CLEAR DOME LID COMBO- 17Lx7Wx2H"/black&clear(80ea/cs)			
															
주문단위	CASE	입수량	150	주문단위	CASE	입수량	150	주문단위	CASE	입수량	90	주문단위	CASE	입수량	80
															
85137548				95138148				85135139				85535018			

IMPERIAL	85135145		
4110600/치킨용기/LARGE CHICKEN ROASTER BLACK BASE AND CLEAR LID NATURES BEST(170ea/cs)			
			
주문단위	CASE	입수량	170
			
95135145			

CONTAINER





















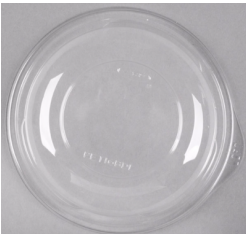



- BODY & LID



IMPERIAL	85131015			IMPERIAL	85131025			IMPERIAL	85131034			IMPERIAL	85136009		
C12DER/사각용기몸통/DART CLEAR CONTAINERS- 12oz/16*6"(1008ea/cs)				C24DER/사각용기몸통/RECTANGLE CONTAINER BASE ONLY Lid:C32DLR FLAT C32DDL R DOME -24oz/clear(504ea/cs)				C32DER/사각용기몸통/RECTANGLE CONTAINER BASE Lid:C32DLR FLAT C32DDL R DOME -32oz/clear(504ea/cs)				04SFL/사각용기뚜껑/LID FOR SQUARE BOWL- 8,12,16,24oz/clear/Base:04S08/YY 4S12/4S18Y/04S24(960/CS)			
															
주문단위	CASE	입수량	1008	주문단위	CASE	입수량	504	주문단위	CASE	입수량	504	주문단위	CASE	입수량	960
															
85131015				85131025				85131034				85136009			

IMPERIAL	85131039			IMPERIAL	85131038			IMPERIAL	85131047			IMPERIAL	85131049		
C32DLR/사각용기수평형뚜껑/FLAT LID FOR RECTANGLE CONTAINER-24,32oz/FLAT LID/Base:C24DER/C32DER(504ea/cs)				C32DDL/사각용기돔형뚜껑/DOME LID FOR RECTANGLE CONTAINER,24/32OZ,DOME LID/Base:C24DER/C32DER(504ea/cs)				C48DER/사각용기몸통/RECTANGLE CONTAINER BASE CLEAR/Lid:C64DLR(FLAT)/C64DDL R(DOME)-48oz(252ea/cs)				C64DDL/사각용기돔형뚜껑,DOME LID FOR RECTANGLE CONTAINER- 48/64OZ(DOME LID/Base:C48DER/C64DER)(252ea/cs)			
															
주문단위	CASE	입수량	504	주문단위	CASE	입수량	504	주문단위	CASE	입수량	252	주문단위	CASE	입수량	252
															
85131039				85131038				85131047				85131049			

IMPERIAL	85136005			IMPERIAL	85136003			IMPERIAL	85136006			IMPERIAL	95136009		
04S08/정사각용기몸통/SQUARE BOWL- 8oz/clear/Lid:04SFL(1000ea/cs)				S18Y/사각용기몸통/SQUARE BOWL- 16oz/clear/Lid:04SFL(480ea/cs)				04S24/정사각형뚜명용기몸통/SQUARE BOWL- 24oz/clearLid:04SFL(500ea/cs)				04SFL/사각용기뚜껑/LID FOR SQUARE BOWL- 8,12,16,24oz/clear/Base:04S08/YY 4S12/4S18Y/04S24(960ea/cs)			
															
주문단위	CASE	입수량	1000	주문단위	CASE	입수량	480	주문단위	CASE	입수량	500	주문단위	CASE	입수량	960
															
85136005				85136003				85136006				95136009			

IMPERIAL	95136003	GSK	95237108	IMPERIAL	85137011	GSK	95237116
4S18Y/사각용기몸통/SQUARE BOWL- 16oz/clear/Lid:04SFL(480ea/cs)		RD8/원형용기/ROUND CONTIANER- 8oz/Clear(500ea/cs)113031		PK12S/반투명원형용기/PLASTIC ROUND CONTAINER- 12oz(500ea/cs)		RD16/원형용기,ROUND CONTIANER-16oz clear(500ea/cs)113036	
							
주문단위	CASE	입수량	480	주문단위	CASE	입수량	500
							
95136003		95237108		85137011		95237116	
GSK	95237119	IMPERIAL	85535010	IMPERIAL	85535011	IMPERIAL	85137112
113049/원형용기뚜껑/LID FOR ROUND CONTAINER- 8/12/16/32oz/Clear(500ea/cs)		PET16B/원형용기/CLR PRESENT BOWLS-16oz(504ea/cs)		PET16BDL/원형용기뚜껑/DOME LID FOR PRESENT BOWLS- 16oz(504ea/cs)		RD12FAB/투명원형용기/CLEAR ROUND CONTAINER- 12oz(500ea/cs)	
							
주문단위	CASE	입수량	500	주문단위	CASE	입수량	504
							
95237119		85535010		85535011		85137112	
IMPERIAL	85137132	IMPERIAL	85137316	IMPERIAL	85137997	IMPERIAL	85137999
RD32FAB/투명원형용기/32 OZ CLEAR ROUND CONTAINER(500ea/cs)		L5016Y/팔죽용기/ROUND DELI CONTAINER-16oz(480ea/cs)		L5032Y/32OZ둥근용기/NEWSPRING BULK DELI CONTAINER BASE(480ea/cs)		NL500/스프링뚜껑/LIDS FOR 8,12,16,32 OZ CONT(480ea/cs)	
							
주문단위	CASE	입수량	500	주문단위	CASE	입수량	480
							
85137132		85137316		85137997		85137999	

IMPERIAL	85122209	IMPERIAL	85139018	GSK	95138148	IMPERIAL	85137012								
12SJ20/원형폼보울/FOAM BOWL ROUND- 3"H/Lid: 12JL/12oz/white(500ea/cs)		12JL/원형 폼 보울 뚜껑/LID FOR FOAM CONTAINER- 12oz/vented/Base: 12SJ20(1000ea/cs)		SR9048W/화이트전자레인지용냉동원형용기/WHITE MICROWAVABLE ROUND CONTAINER- 9"/48oz/rgr(150ea/cs)		VBPK8S/반투명투고원형용기/VICTORIA BAY PLASTIC ROUND TAKE OUT CONTAINER BASE- 4.6x1.7"/8oz/clear(500ea/cs)									
															
주문단위	CASE	입수량	500	주문단위	CASE	입수량	1000	주문단위	CASE	입수량	150	주문단위	CASE	입수량	500
		85122209				85139018				95138148				85137012	
IMPERIAL	85137336	IMPERIAL	85137016	GSK	95562190	GSK	95562191								
VBPK16S/반투명원형용기/16 OZ Clear Round PP 1 Compartment Take-Out Container- 16oz/clear(500ea/cs)		VBPLID/반투명원형용기뚜껑/Clear Round PP Flat Plug Fit Lid- 8,12,16,24,32oz/clear(500ea/cs)		NEW-전복3구/전복3구몸통/ABALONE PLASTIC TRAY BODY- 9.44Wx4.3Lx0.87H"/pla/green(500ea/cs)		NEW-전복3구/전복3구뚜껑/ABALONE PLASTIC TRAY LID- 9.44Wx4.3Lx0.5H"/pla/clear(500ea/cs)									
															
주문단위	CASE	입수량	500	주문단위	CASE	입수량	500	주문단위	CASE	입수량	500	주문단위	CASE	입수량	500
		85137336				85137016				95562190				95562191	
GSK	95941343	GSK	95941344												
1151877/손잡이달린밀폐원형용기/CLEAR TAMPER EVIDENT ROUND CONTAINER WITH HANDLE- 85oz/2.5L(184ea/cs)		PC5LBCLRV/밀폐원형용기뚜껑/CLEAR ROUND VENTED COVER LID FOR 85OZ- 170mm/6.7"(828ea/cs)													
															
주문단위	CASE	입수량	184	주문단위	CASE	입수량	828								
		95941343				95941344									

CONTAINER

- SUSHI & BENTO

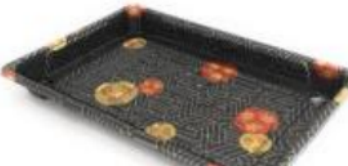

GSK	95160219			GSK	95160220			GSK	95160208			GSK	95160209		
TZ-001 BODY / 스시용기몸통 / SUSHI CONTAINER BASE-8-3/4x3-3/4x7/8" (1400ea/cs)				TZ-001 LID / 스시용기뚜껍 / SUSHI CONTAINER LID-8-3/4x3-4/5x1-3/8" (1400ea/cs)				TZ-008 / 스시용기몸통 / SUSHI CONTAINER BASE-6-1/2x4-1/2x3/4" (1500ea/cs)				TZ-008 LID / 스시용기뚜껍 / SUSHI CONTAINER LID-6-1/2x4-1/2x1-1/8" (1500ea/cs)			
															
주문단위	CASE	입수량	1400	주문단위	CASE	입수량	1400	주문단위	CASE	입수량	1500	주문단위	CASE	입수량	1500
															
95160219				95160220				95160208				95160209			

GSK	95160210			GSK	95160211			GSK	95160215			GSK	95160216		
TZ-010 BODY / 스시용기몸통 / SUSHI CONTAINER BASE-7-3/8"x5-1/8"x7/8" (1200ea/cs)				TZ-010 LID / 스시용기뚜껍 / SUSHI CONTAINER LID-7-3/8x5-1/8x1-1/8" (1200ea/cs)				TZ-015 BODY / 스시용기몸통 / SUSHI CONTAINER BASE-8-1/2x5-3/8x3/4" (1000ea/cs)				KST-015 LID / 스시용기뚜껍 / SUSHI CONTAINER LID-8-1/2x5-3/8x1-1/8" (1000ea/cs)			
															
주문단위	CASE	입수량	1200	주문단위	CASE	입수량	1200	주문단위	CASE	입수량	1000	주문단위	CASE	입수량	1000
															
95160210				95160211				95160215				95160216			

GSK	95160217			GSK	95160218			GSK	95160221			GSK	95160222		
TZ-020 BODY / 스시용기몸통 / SUSHI CONTAINER BASE-8-1/2x5-3/8x3/4" (800ea/cs)				TZ-020 LID / 스시용기 뚜껍 / SUSHI CONTAINER LID-9-3/8x5-3/4x1-1/8" (800ea/cs)				TZ-025 BODY / 스시용기몸통 / SUSHI CONTAINER BASE-10-1/4x7-3/8x7/8" (504ea/cs)				TZ-025 LID / 스시용기뚜껍 / SUSHI CONTAINER LID-10-1/4x7-3/8x1-3/8" (504ea/cs)			
															
주문단위	CASE	입수량	800	주문단위	CASE	입수량	800	주문단위	CASE	입수량	504	주문단위	CASE	입수량	504
															
95160217				95160218				95160221				95160222			

GSK	95160260	GSK	95160261	GSK	95160262	GSK	95160264
TZ-06 WGF BODY/우드스시용기 몸통/SUSHI CONTAINER BASE-6 3/8 X 3 1/2 X 3/4/wood(1500ea/cs)		TZ-06 LID/스시용기뚜껑/SUSHI CONTAINER LID-6 3/8 X 3 1/2X1 1/8 "(1500ea/cs)		TZ-001 WGF BODY/우드스시용기 몸통/SUSHI CONTAINER BASE-8 3/4 X 3 3/4 X 7/8/wood(1400ea/cs)		TZ-008 WGF BODY/우드스시용기 몸통/SUSHI CONTAINER BASE-6 1/2 X 4 1/2 X 3/4/wood(1500ea/cs)	
							
주문단위	CASE	입수량	1500	주문단위	CASE	입수량	1500
							
95160260		95160261		95160262		95160264	

GSK	95160266	GSK	95160268	GSK	95160270	GSK	95160271
TZ-010 WGF BODY/우드스시용기 몸통/SUSHI CONTAINER BASE-7 3/8 X 5 1/8 X 7/8/wood(1200ea/cs)		TZ-015 WGF BODY/우드스시용기 몸통/SUSHI CONTAINER BASE-8 1/2 X 5 1/4 X 5/8/wood(1000ea/cs)		TZ-020 WGF BODY/우드스시용기 몸통/SUSHI CONTAINER BASE-9 1/4 X 5 3/4 X 3/4/wood(800ea/cs)		TZ-020 WGF LID/우드스시용기뚜껑/SUSHI CONTAINER LID-9 3/8 X 5 3/4 X 1 1/8/wood(800ea/cs)	
							
주문단위	CASE	입수량	1200	주문단위	CASE	입수량	1000
							
95160266		95160268		95160270		95160271	

GSK	95160318	GSK	95160317	GSK	95160316	GSK	95160431
TZ-305/5등분도시락용기콤보 /BENTO BOX COMBO-9-3/8x7-1/2x1-3/8"(252ea/cs)		TZ-306/5등분도시락용기콤보 /BENTO BOX COMBO-10-1/2x8-1/8x2",5(200ea/cs)		TZ-307/5등분도시락용기콤보 /BENTO BOX COMBO-10-5/8x10-5/8x2",5(100ea/cs)		TZ-807/1등분 도시락 용기 콤보 /LUNCH BOX COMBO/6-1/2"x5"x2"(550ea/cs)	
							
주문단위	CASE	입수량	252	주문단위	CASE	입수량	200
							
95160318		95160317		95160316		95160431	

GSK	95160430	GSK	95160238	GSK	95160230	GSK	95160231
TZ-830/1등분 도시락 용기 콤보 /LUNCH BOX COMBO-10- 1/2x8x2"(200ea/cs)		TZ-W008/흰색스시용기콤보 /SUSHI CONTAINER COMBO WHITE-6-1/2"x4- 1/2"x3/4"(440ea/cs)		TZ-W010/흰색스시용기콤보 /SUSHI CONTAINER COMBO WHITE-7-3/8"x5-1/8"x1- 1/8"(400ea/cs)		TZ-W001/흰색스시용기콤보 /SUSHI CONTAINER COMBO WHITE-8-3/4x3- 3/4x7/8"(400ea/cs)	
							
주문단위	CASE	입수량	200	주문단위	CASE	입수량	440
							
95160430		95160238		95160230		95160231	
GSK	95160254	GSK	95160251	GSK	95160253	GSK	95562223
TZ-130/투명블루스시콘테이너콤보 /CLEAR BLUE SUSHI CONTAINER COMBO-9-1/2"x4-3/4"x1- 1/2",N/A(360ea/cs)		TZ-140/투명블루스시콘테이너콤보 /Clear Blue Sushi Container Combo-7-1/2"x7-1/2"x1- 1/2"(280ea/CS)		TZ-150/투명블루스시콘테이너콤보 /CLEAR BLUE SUSHI CONTAINER COMBO-9.5x7.5x1.5"(200ea/cs)		DR-PACK 37-3호(B)/초밥검척무 늑몸통/SUSHI TRAY BODY- 320Wx106Lx22H"/pla./black&red (200ea/cs)	
							
주문단위	CASE	입수량	360	주문단위	CASE	입수량	280
							
95160254		95160251		95160253		95562223	
GSK	95562224	GSK	95562211	GSK	95562212	GSK	95562213
DR-PACK 37-3호(C)/초밥검척무 늑뚜껑/SUSHI TRAY LID- 324Wx110Lx30H"/pla./clear(200ea /cs)		E-초밥17/초밥17호트레이몸통 /SUSHI TRAY BODY- 9.85Wx6.19Lx1.22H"/pla./red(300ea /cs)		E-초밥17/초밥17호트레이뚜껑 /SUSHI TRAY LID- 9.85Wx6.19Lx1.14H"/pla./clear(300e a/cs)		E-초밥21/초밥21호트레이몸통 /SUSHI TRAY BODY- 13.4Wx7.29Lx0.99H"/pla./gold(200e a/cs)	
							
주문단위	CASE	입수량	200	주문단위	CASE	입수량	300
							
95562224		95562211		95562212		95562213	

GSK	95562214	GSK	95562188	GSK	95562189	GSK	95562192
E-초밥21/초밥21호트레이뚜껑 /SUSHI TRAY LID- 13.6Wx7.48Lx0.99H"/pla/clear(200ea/cs)		ECO-200/물고기모양스시트레이 몸통/FISH SHAPE PLASTIC TRAY BODY- 14.17Wx9.45Lx1.77H"/pla/redplum(100ea/cs)		ECO-200/물고기모양스시트레이 뚜껑/FISH SHAPE PLASTIC TRAY LID- 14.17Wx8.45Lx1.2H"/pla/clear(100ea/cs)		E-회1줄/한줄스시용트레이 /SUSHI PLASTIC TRAY- 4.41Wx9.72Lx0.67H"/pla/bluegold(400ea/cs)	
							
주문단위	CASE	입수량	200	주문단위	CASE	입수량	100
							
95562214		95562188		95562189		95562192	
GSK	95562193	GSK	95562194	GSK	95562195	GSK	95562196
E-회1줄/한줄스시용트레이뚜껑 /SUSHI PLASTIC LID- 6.61Wx11.81Lx1.14H"/pla/clear(400ea/cs)		DRE-선4호/배모양스시트레이몸 통/SHIP SHAPE SUSHI TRAY BODY- 13.58Wx7.48Lx2.2H"/pla/blue(200ea/cs)		DRE-선4호/배모양스시트레이뚜 껑/SHIP SHAPE SUSHI TRAY LID- 13.58Wx7.48Lx1.65H"/pla/clear(200ea/cs)		GSKHT-BK/하트모양스시트레이몸 통/HEART SHAPE SUSHI TRAY BODY- 9.8Wx8.94Lx1.3H"/pla/blackgold(200ea/cs)	
							
주문단위	CASE	입수량	400	주문단위	CASE	입수량	200
							
95562193		95562194		95562195		95562196	
GSK	95562197	GSK	95562198	GSK	95562199	GSK	95562209
GSKHT-R/하트모양스시트레이몸 통/HEART SHAPE SUSHI TRAY BODY- 9.8Wx8.94Lx1.3H"/pla/red(200ea/cs)		GSKHT-BL/하트모양스시트레이몸 통/HEART SHAPE SUSHI TRAY BODY- 9.8Wx8.94Lx1.3H"/pla/bluegold(200ea/cs)		GSKHT-LD/하트모양스시트레이뚜 껑/HEART SHAPE SUSHI TRAY LID- 9.8Wx8.94Lx1H"/pla/clear(200ea/cs)		LM-초밥34/초밥34호트레이몸통 /SUSHI TRAY BODY- 14.30Wx7.6Lx0.91H"/pla/gold(200ea/cs)	
							
주문단위	CASE	입수량	200	주문단위	CASE	입수량	200
							
95562197		95562198		95562199		95562209	

GSK		95562210	
LM-초밥34/초밥34호트레이뚜껑 /SUSHI TRAY BODY- 14.50Wx7.8Lx1.18H"/pla/clear(200ea/cs)			
			
주문단위	CASE	입수량	200
 95562210			

TRAY

- FOAM TRAY



IMPERIAL		85945021		IMPERIAL		85945041		IMPERIAL		85945010		IMPERIAL		85945009	
EA77B&G/4P 블랙&골드폼트레이 /4P BLACK&GOLD FOAM TRAY- (300ea/cs)				EA1001B&G/8H 블랙&골드폼트레이 /8H BLACK&GOLD FOAM TRAY-(300ea/cs)				EA77BC/4P 블루체크폼트레이/4P BLUE CHECK FOAM TRAY- (300ea/cs)				EA1001BC/8H 블루 체크 폼트레이 /8H BLUE CHECK FOAM TRAY- (300ea/cs)			
															
주문단위	CASE	입수량	300	주문단위	CASE	입수량	300	주문단위	CASE	입수량	300	주문단위	CASE	입수량	300
															
85945021				85945041				85945010				85945009			

TRAY

- PP TRAY



GSK	95562144	GSK	95562145	GSK	95562146	GSK	95562147								
GSK10K-BK-27314651/10K 블랙 플라스틱트레이/10K PLASTIC TRAY- 273x146x51mm/blakc(200ea/cs)		GSK10K-CL-27314651/10K 클리 어플라스틱트레이/10K PLASTIC TRAY- 273x146x51mm/clear(200ea/cs)		GSK10K-PK-27314651/10K 핑크 플라스틱트레이/10K PLASTIC TRAY- 273x146x51mm/pink(200ea/cs)		GSK10K-YL-27314651/10K 옐로 우플라스틱트레이/10K PLASTIC TRAY- 273x146x51mm/yellow(200ea/cs)									
															
주문단위	CASE	입수량	200	주문단위	CASE	입수량	200	주문단위	CASE	입수량	200	주문단위	CASE	입수량	200
															
95562144		95562145		95562146		95562147									
GSK	95562138	GSK	95562139	GSK	95562140	GSK	95562141								
GSK10S-BK-27313626/10S 블랙 플라스틱트레이/10S PLASTIC TRAY- 273x136x26mm/black(400ea/cs)		GSK10S-BU-27313626/10S 블루 플라스틱트레이/10S PLASTIC TRAY- 273x136x26mm/blue(400ea/cs)		GSK10S-CL-27313626/10S 클리 어플라스틱트레이/10S PLASTIC TRAY- 273x136x26mm/clear(440ea/cs)		GSK10S-PK-27313626/10S 핑크 플라스틱트레이/10S PLASTIC TRAY- 273x136x26mm/pink(400ea/cs)									
															
주문단위	CASE	입수량	400	주문단위	CASE	입수량	400	주문단위	CASE	입수량	440	주문단위	CASE	입수량	400
															
95562138		95562139		95562140		95562141									
GSK	95562142	GSK	95562143	GSK	95562148	GSK	95562149								
GSK10S-WT-27313626/10S 화이 트플라스틱트레이/10S PLASTIC TRAY- 273x136x26mm/white(400ea/cs)		GSK10S-YL-27313626/10S 옐로 우플라스틱트레이/10S PLASTIC TRAY- 273x136x26mm/yellow(400ea/cs)		GSK1525S-CL-37520326/1525S 클리어플라스틱트레이/1525S PLASTIC TRAY- 375x203x26mm/clear(120ea/cs)		GSK1525S-WT-37520326/1525S 화이트플라스틱트레이/1525S PLASTIC TRAY- 375x203x26mm/white(120ea/cs)									
															
주문단위	CASE	입수량	400	주문단위	CASE	입수량	400	주문단위	CASE	입수량	120	주문단위	CASE	입수량	120
															
95562142		95562143		95562148		95562149									

GSK	95562150	GSK	95562151	GSK	95562152	GSK	95562153
GSK 1525S-YL-37520326/1525S 옐로우플라스틱트레이/1525S PLASTIC TRAY- 375x203x26mm/yellow(120ea/cs)		GSK 16S-CL-31118426/16S 클리 어플라스틱트레이/16S PLASTIC TRAY- 311x184x26mm/clear(260ea/cs)		GSK 16S-PK-31118426/16S 핑크 플라스틱트레이/16S PLASTIC TRAY- 311x184x26mm/pink(260ea/cs)		GSK 16S-YL-31118426/16S 옐로 우플라스틱트레이/16S PLASTIC TRAY- 311x184x26mm/yellow(260ea/cs)	
							
주문단위	CASE	입수량	120	주문단위	CASE	입수량	260
							
95562150		95562151		95562152		95562153	
GSK	95562121	GSK	95562122	GSK	95562123	GSK	95562124
GSK2-BK-21014626/2P 블랙플라 스틱트레이/2P PLASTIC TRAY- 210x146x26mm/black(400ea/cs)		GSK2-BU-21014626/2P 블루플라 스틱트레이/2P PLASTIC TRAY- 210x146x26mm/blue(400ea/cs)		GSK2-CL-21014626/2P 클리어플 라스틱트레이/2P PLASTIC TRAY- 210x146x26mm/clear(480ea/cs)		GSK2-PK-21014626/2P 핑크플라 스틱트레이/2P PLASTIC TRAY- 210x146x26mm/pink(400ea/cs)	
							
주문단위	CASE	입수량	400	주문단위	CASE	입수량	400
							
95562121		95562122		95562123		95562124	
GSK	95562125	GSK	95562154	GSK	95562155	GSK	95562156
GSK2-YL-21014626/2P 옐로우플 라스틱트레이/2P PLASTIC TRAY- 210x146x26mm/yellow(400ea/cs)		GSK20K-CL-30222262/20K 클리 어플라스틱트레이/20K PLASTIC TRAY- 302x222x62mm/clear(100ea/cs)		GSK20K-PK-30222262/20K 핑크 플라스틱트레이/20K PLASTIC TRAY- 302x222x62mm/pink(100ea/cs)		GSK20K-WT-30222262/20K 화이 트플라스틱트레이/20K PLASTIC TRAY- 302x222x62mm/white(100ea/cs)	
							
주문단위	CASE	입수량	400	주문단위	CASE	입수량	100
							
95562125		95562154		95562155		95562156	

GSK	95562157			GSK	95562158			GSK	95562161			GSK	95562160		
GSK20K-YL-30222262/20K 옐로우플라스틱트레이/20K PLASTIC TRAY-302x222x62mm/yellow(100ea/cs)				GSK4DD-CL/4DD 클리어플라스틱트레이/4DD PLASTIC TRAY-235X184X45mm/clear(100ea/cs)				GSK4DD-PK/4DD 핑크플라스틱트레이/4DD PLASTIC TRAY-235X184X45mm/pink(100ea/cs)				GSK4DD-WT/4DD 화이트플라스틱트레이/4DD PLASTIC TRAY-235X184X45mm/white(100ea/cs)			
															
주문단위	CASE	입수량	100	주문단위	CASE	입수량	100	주문단위	CASE	입수량	100	주문단위	CASE	입수량	100
															
95562157				95562158				95562161				95562160			
GSK	95562159			GSK	95562131			GSK	95562132			GSK	95562133		
GSK4DD-YL/4DD 옐로우플라스틱트레이/4DD PLASTIC TRAY-235X184X45mm/yellow(100ea/cs)				GSK7S-CL-36712626/7S 클리어플라스틱트레이/7S PLASTIC TRAY-367x126x26mm/clear(260ea/cs)				GSK7S-PK-36712626/7S 핑크플라스틱트레이/7S PLASTIC TRAY-367x126x26mm/pink(220ea/cs)				GSK7S-YL-36712626/7S 옐로우플라스틱트레이/7S PLASTIC TRAY-367x126x26mm/yellow(220ea/cs)			
															
주문단위	CASE	입수량	100	주문단위	CASE	입수량	260	주문단위	CASE	입수량	220	주문단위	CASE	입수량	220
															
95562159				95562131				95562132				95562133			
GSK	95562126			GSK	95562127			GSK	95562128			GSK	95562129		
GSKTRO4P-BK-23518429/4P 블랙플라스틱트레이/4P PLASTIC TRAY-235x184x29mm/black(100ea/cs)				GSKTRO4P-CL-23518429/4P 클리어플라스틱트레이/4P PLASTIC TRAY-235x184x29mm/clear(120ea/cs)				GSKTRO4P-PK-23518429/4P 핑크플라스틱트레이/4P PLASTIC TRAY-235x184x29mm/pink(100ea/cs)				GSKTRO4P-WT-23518429/4P 화이트플라스틱트레이/4P PLASTIC TRAY-235x184x29mm/white(100ea/cs)			
															
주문단위	CASE	입수량	100	주문단위	CASE	입수량	120	주문단위	CASE	입수량	100	주문단위	CASE	입수량	100
															
95562126				95562127				95562128				95562129			

GSK	95562130	GSK	95562134	GSK	95562135	GSK	95562136
GSKTRO4P-YL-23518429/4P 엘로우플라스틱트레이/4P PLASTIC TRAY- 235x184x29mm/yellow(100ea/cs)		GSKTRO8P-CL-26721026/8P 클리어플라스틱트레이/8P PLASTIC TRAY- 267x210x26mm/clear(260ea/cs)		GSKTRO8P-PK-26721026/8P 핑크플라스틱트레이/8P PLASTIC TRAY- 267x210x26mm/pink(200ea/cs)		GSKTRO8P-WT-26721026/8P 화이트플라스틱트레이/8P PLASTIC TRAY- 267x210x26mm/white(200ea/cs)	
							
주문단위	CASE	입수량	100	주문단위	CASE	입수량	260
							
95562130		95562134		95562135		95562136	
GSK	95562137	GSK	95170317	GSK	95562203	GSK	95562204
GSKTRO8P-YL-26721026/8P 엘로우플라스틱트레이/8P PLASTIC TRAY- 267x210x26mm/yellow(200ea/cs)		MT-25S-CL/플라스틱 트레이/PETE TRAY-14-3/4"x8"x1",25s clear(200ea/cs)		H-261705/2구투명트레이/2 COMPARTMENT CLEAR SMALL TRAY- 258x173Lx50mm/clear(200ea/cs)		H-261705/2구핑크트레이/2 COMPARTMENT PINK SMALL TRAY- 258x173Lx50mm/pink(200ea/cs)	
							
주문단위	CASE	입수량	200	주문단위	CASE	입수량	200
							
95562137		95170317		95562203		95562204	
GSK	95562205	GSK	95562206	GSK	95562207		
H-261705/2구우드트레이/2 COMPARTMENT WOOD SMALL TRAY- 258x173Lx50mm/wood(200ea/cs)		H-13-1/2구투명트레이/2 COMPARTMENT CLEAR MEDIUM TRAY- 13Wx10Lx2.76H"/clear(200ea/cs)		H-16-1/3구투명트레이/3 COMPARTMENT CLEAR MEDIUM TRAY- 13Wx10Lx2.76H"/clear(200ea/cs)			
							
주문단위	CASE	입수량	200	주문단위	CASE	입수량	200
							
95562205		95562206		95562207			

TRAY



- SPECIAL TRAY



GSK	95562168			GSK	95562177			GSK	95562162			GSK	95562173		
GSK2-BG-21014626/2P블랙앤골드트레이/2P BLACK & GOLD DESIGN PLASTIC TRAY-green tape/210x146x26mm(400ea./cs)				GSK2-BL-21014626/2P남색청죽트레이/2P NAVY BAMBOO DESIGN PLASTIC TRAY-orange tape/210x146x26mm(400ea./cs)				GSK2-WD-21014626/2P우드트레이/2P WOOD DESIGN PLASTIC TRAY-red tape/210x146x26mm(400ea./cs)				GSK2-PF-21014626/2P수산트레이/2P FISH DESIGN PLASTIC TRAY-purple tape/210x146x26mm(400ea./cs)			
															
주문단위	CASE	입수량	400	주문단위	CASE	입수량	400	주문단위	CASE	입수량	400	주문단위	CASE	입수량	400
															
95562168				95562177				95562162				95562173			

GSK	95562169			GSK	95562178			GSK	95562163			GSK	95562174		
GSKTRO4P-BG-23518429/4P블랙앤골드트레이/4P BLACK & GOLD DESIGN PLASTIC TRAY-green tape/235x184x29mm(100ea./cs)				GSKTRO4P-BL-23518429/4P남색청죽트레이/4P NAVY BAMBOO DESIGN PLASTIC TRAY-orange tape/235x184x29mm(100ea./cs)				GSKTRO4P-WD-23518429/4P우드트레이/4P WOOD DESIGN PLASTIC TRAY-red tape/235x184x29mm(100ea./cs)				GSKTRO4P-PF-23518429/4P수산트레이/4P FISH DESIGN PLASTIC TRAY-purple tape/235x184x29mm(100ea./cs)			
															
주문단위	CASE	입수량	100	주문단위	CASE	입수량	100	주문단위	CASE	입수량	100	주문단위	CASE	입수량	100
															
95562169				95562178				95562163				95562174			

GSK	95562170			GSK	95562179			GSK	95562164			GSK	95562175		
GSKTRO8P-BG-26721026/8P블랙앤골드트레이/8P BLACK & GOLD DESIGN PLASTIC TRAY-green tape/267x210x26mm(200ea./cs)				GSKTRO8P-BL-26721026/8P남색청죽트레이/8P NAVY BAMBOO DESIGN PLASTIC TRAY-orange tape/267x210x26mm(200ea./cs)				GSKTRO8P-WD-26721026/8P우드트레이/8P WOOD DESIGN PLASTIC TRAY-red tape/267x210x26mm(200ea./cs)				GSKTRO8P-PF-26721026/8P수산트레이/8P FISH DESIGN PLASTIC TRAY-purple tape/267x210x26mm(200ea./cs)			
															
주문단위	CASE	입수량	200	주문단위	CASE	입수량	200	주문단위	CASE	입수량	200	주문단위	CASE	입수량	200
															
95562170				95562179				95562164				95562175			

























GSK	95562172			GSK	95562180			GSK	95562167			GSK	95562176		
GSK 10S-BG-27313626/10S블랙안골드트레이/10S BLACK & GOLD DESIGN PLASTIC TRAY-green tape/273x136x26mm(400ea./cs)				GSK 10S-BL-27313626/10S남색청죽트레이/10S NAVY BAMBOO DESIGN PLASTIC TRAY-orange tape/273x136x26mm(400ea./cs)				GSK 10S-WD-27313626/10S우드트레이/10S WOOD DESIGN PLASTIC TRAY-red tape/273x136x26mm(400ea./cs)				GSK 10S-PF-27313626/10S수산트레이/10S FISH DESIGN PLASTIC TRAY-purple tape/273x136x26mm(400ea./cs)			
															
주문단위	CASE	입수량	400	주문단위	CASE	입수량	400	주문단위	CASE	입수량	400	주문단위	CASE	입수량	400
															
95562172				95562180				95562167				95562176			
GSK	95562171			GSK	95562166			GSK	95562183			GSK	95562184		
GSK 16S-BG-31118426/16S블랙안골드트레이/16S BLACK & GOLD DESIGN PLASTIC TRAY-green tape/311x184x26mm(220ea./cs)				GSK 16S-WD-31118426/16S우드트레이/16S WOOD DESIGN PLASTIC TRAY-red tape/311x184x26mm(220ea./cs)				GSK-R1-LWD/R1부채꼴우드트레이/R1 WOOD DESIGN PLASTIC TRAY-28X18(400ea./cs)				GSK-R1-BKG/R1부채꼴블랙안골드트레이/R1 BLACK AND GOLD DESIGN PLASTIC TRAY-28X18(400ea./cs)			
															
주문단위	CASE	입수량	220	주문단위	CASE	입수량	220	주문단위	CASE	입수량	400	주문단위	CASE	입수량	400
															
95562171				95562166				95562183				95562184			

TRAY

- ETC



GSK	95562200	GSK	95562230	GSK	95562201	GSK	95562231								
SSDY215/나무도시락/DIY WOODEN PASTRY CONTAINER W/ WOODEN LID- 215x120x45mm/8.5x4.8x1.8"/small(100set/cs)		SSDY215/나무도시락이너케이스/WOODEN PASTRY CONTAINER INNER- 215x120x45mm/8.5x4.8x1.8"/small/black(200ea/cs)		SSDY027/나무도시락/DIY WOODEN PASTRY CONTAINER W/ WOODEN LID- 240x160x50mm/9.5x6.3x2"/large(100set/cs)		SSDY027/나무도시락이너케이스/WOODEN PASTRY CONTAINER INNER- 240x160x50mm/9.5x6.3x2"/large/black(200ea/cs)									
															
주문단위	CASE	입수량	100	주문단위	CASE	입수량	200	주문단위	CASE	입수량	100	주문단위	CASE	입수량	200
															
GSK	95562202	GSK	95562232	IMPERIAL	85124162	GSK	95160311								
SSDY200/나무도시락/DIY WOODEN PASTRY CONTAINER W/ WOODEN LID- 200x200x50mm/7.9x7.9x2"/square(100set/cs)		SSDY200/나무도시락이너케이스/WOODEN PASTRY CONTAINER INNER- 200x200x50mm/7.9x7.9x2"/square/black(200ea/cs)		BG-ST-2-L/#1에코스시트레이 뚜껑/LID FOR ECO LONG SUSHI TRAY(1000ea/cs)		TZ-100S/정사각파티트레이콤보/SQUARE CATERING TRAY COMBO-10-1/8"x10-1/8"x1-5/8"(120ea/cs)									
															
주문단위	CASE	입수량	100	주문단위	CASE	입수량	200	주문단위	CASE	입수량	1000	주문단위	CASE	입수량	120
															
GSK	95160364	GSK	95160365	IMPERIAL	85137333	IMPERIAL	85137335								
TZ-64B/둥근 파티 트레이/ROUND PARTY TRAY-12"(60ea/cs)		TZ-63/둥근파티트레이/ROUND PARTY TRAY-11"(60ea/cs)		7324C/7인치플래터/7" PLATTER 4 COMPARTMENT/32oz 205-040527(300ea/cs)		7JLSM/4분할 원형용기뚜껑/LID FOR 4COMP PLATTER-7"/32oz/clear/Base:7324C(300ea/cs)									
															
주문단위	CASE	입수량	60	주문단위	CASE	입수량	60	주문단위	CASE	입수량	300	주문단위	CASE	입수량	300
															

IMPERIAL	85124120	IMPERIAL	85124112	IMPERIAL	85124113	IMPERIAL	85124121
320W / 흰색트레이 / WHITE CATERING TRAY HVY DUTY - 12" / white(25ea/cs)		712PBL / 스티플래터 / 220B CATERING PLATTER - 12" / black(25ea/cs)		A12PETDM / 원형 스티플래터 뚜껑 / 320L LID FOR CATERING PLATTER - 12" / clear(25ea/cs)		340W / 원형스티플래터 / WHITE ROUND CATERING PLATTER - 14" (25ea/cs)	
							
주문단위	CASE	입수량	25	주문단위	CASE	입수량	25
							
85124120		85124112		95124113		85124121	
IMPERIAL	85124115	IMPERIAL	85124122	IMPERIAL	85124117	IMPERIAL	85124136
340L / 원형스티플래터뚜껑 / 340L LID FOR CATERING PLATTER / 14" - clear(25ea/cs)		360W / 원형스티플래터 / WHITE ROUND CATERING PLATTER - 16" (25ea/cs)		360L / 원형스티플래터뚜껑 / 360L LID FOR CATERING PLATTER / 16" - clear(25ea/cs)		816ST / 원형스티플래터 / ROUND CATERING PLATTER - 16" (32ea/cs)	
							
주문단위	CASE	입수량	25	주문단위	CASE	입수량	25
							
85124115		85124122		85124117		85124136	
IMPERIAL	85124137	IMPERIAL	85124111	IMPERIAL	85124110	IMPERIAL	85124135
5516ST / 16" 스티플래터뚜껑 / DOME LID FOR 16" SABERT TRAY(36ea/CS)		380W / 원형스티플래터 / ROUND CATERING WHITE PLATTER - 18" (25ea/cs)		380L / 원형스티플래터뚜껑 / 380L LID FOR CATERING PLATTER / 18" - clear(25ea/cs)		9918 / 원형스티플래터 / ROUND CATERING PLATTER - 18" / black(36ea/cs)	
							
주문단위	CASE	입수량	36	주문단위	CASE	입수량	25
							
85124137		85124111		85124110		85124135	

IMPERIAL	85523001	IMPERIAL	85124139	IMPERIAL	85523002	IMPERIAL	81000223								
A518PBL/원형스시플래터/TRAY BLACK PLASTIC-18" (25ea/cs)		5518ST/뚜껑18"스시플래터 /DOME LID FOR SABERT TRAY- 18"(36ea/cs)		A18PETDM/원형스시플래터뚜껑 /DOME LID FOR- 18x2.75" (25ea/cs)		2046HFA/원형알루미늄팬트레이 /ROUND PAN TRAY-9 DIAx1- 5/8"D,SHALLOW TRAY/LD34,(500ea/cs)									
															
주문단위	CASE	입수량	25	주문단위	CASE	입수량	36	주문단위	CASE	입수량	25	주문단위	CASE	입수량	500
															
95523001		85124139		95523002		81000223									
IMPERIAL	85179211	IMPERIAL	85179208	IMPERIAL	85179210	IMPERIAL	85123212								
LD34/원형알루미늄팬트레이뚜껑 /LID FOR ROUND PAN TRAY,8- 7/8"DIA,9"/2046HFA/DOME LID(500ea/cs)		2058HFA/원형알루미늄팬트레이 /ROUND PAN TRAY-8"DIAx1- 1/2"D,SHALLOW TRAY/LD36,(500ea/cs)		LD36/원형알루미늄팬트레이뚜껑 /LID FOR ROUND PAN TRAY,8- 1/4"DIA,8" (500ea/cs)		FC103/3상섬유접시/3 COMP FIBER PLATE- 10" /white/(500ea/cs)									
															
주문단위	CASE	입수량	500	주문단위	CASE	입수량	500	주문단위	CASE	입수량	500	주문단위	CASE	입수량	500
															
85179211		85179208		85179210		85123212									
IMPERIAL	85539001	GSK	91062001	IMPERIAL	85179171	IMPERIAL	85179112								
DU5006501/폼보울/BOWL FOAM WHT RND UNLAMINATED- 12oz(1000ea/cs)		795T732RC/레드체크페이퍼푸드트 레이(랍스터용)/RED CHECK PAPER FOOD TRAY-(1000ea/cs)		2019HFA/사각알루미늄팬트레이 /STEAM PAN TRAY-20- 3/4"x12-3/4"x3- 1/4"/(50ea/cs)		321HFA/사각알루미늄팬트레이 /STEAM PAN TRAY-12 3/4x10 3/8x 2 9/16"-half size,deep(100ea/cs)									
															
주문단위	CASE	입수량	100	주문단위	CASE	입수량	1000	주문단위	CASE	입수량	50	주문단위	CASE	입수량	100
															
85539001		91062001		85179171		85179112									

GSK		91000013		GSK		91000014		GSK		91062007	
2050HFA / 알루미늄 풀사이즈 뚜껑 / ALUMINUM LID FOR FULL SIZE STEAM TABLE(50ea/cs)				2049HFA / 알루미늄 중간사이즈 뚜껑 / ALUMINUM LID FOR HALF SIZE STEAM TABLE(100ea/cs)				214PKITROLBK / 시식대 슬라이딩 돔 커버트레이 / POLYCARBONATE TRAY AND ROLL TOP COVER- 12"x20" / black			
											
주문단위	CASE	입수량	50	주문단위	CASE	입수량	100	주문단위	EACH	입수량	1
											
91000013				91000014				91062007			

BOWL



IMPERIAL	85122214	IMPERIAL	85122215	IMPERIAL	85122132	IMPERIAL	85122139
B24SB/사각보울몸통/SQUARE BOWL- 24oz/black/Lid:C2464BDL(252ea/cs)		C2464BDL/사각보울뚜껑/LID FOR SQUARE BOWL BASE:B24SB- 24oz/clear(252ea/cs)		18032ST/사각보울몸통/SQUARE BOWL Lid:52800ST- 32oz(300ea/cs)		52800ST/사각보울뚜껑/LID FOR SQUARE BOWL Base:18032ST- 32oz(300ea/cs)	
							
주문단위	CASE	입수량	252	주문단위	CASE	입수량	252
							
85122214		85122215		85122132		85122139	
IMPERIAL	85535013	IMPERIAL	85124150	IMPERIAL	85124153	IMPERIAL	85124147
12048/48 OZ 클리어 원형 보울 용기/ROUND FOOD SERVING BOWL-48oz/clear(100ea/cs)		51048/작은회덮밥용기뚜껑/LID FOR 48 OZ SABERT 12048 BOWL(100ea/cs)		52048A/SABERT용기돔형뚜껑 /24,32,48OZ SHALLOW BOWL(100ea/cs)		92080/원형보울용기/SABERT 80OZ BLACK BOWLROUND FOOD SERVING BOWL- 80oz/black(50ea/cs)	
							
주문단위	CASE	입수량	100	주문단위	CASE	입수량	100
							
85535013		85124150		85124153		85124147	
IMPERIAL	85124148	GSK	95160321	GSK	95160322	IMPERIAL	85122209
52080A/회덮밥용기돔형뚜껑/DOME LID FOR 80 OZ SABERT BOWL(50ea/cs)		TZ362B/전자렌지용스프보울 /MICRO SOUP BOWL TZ-362 BODY-6-7/8(DIA)x2- 1/2"(260ea/cs)		TZ362L/원형스프보울뚜껑/LID FOR ROUND MICROWABLE BOWL- 7-1/8"(DIA)x7/8"(260ea/cs)		12SJ20/원형폼보울/FOAM BOWL ROUND- 3"H/Lid:12JL/12oz/white(500ea/cs)	
							
주문단위	CASE	입수량	50	주문단위	CASE	입수량	260
							
85124148		95160321		95160322		85122209	

IMPERIAL	85139018	IMPERIAL	85539002	IMPERIAL	85539003	IMPERIAL	85539004								
12JL/원형 폼 보울 뚜껑/LD FOR FOAM CONTAINER-12oz/vented/Base: 12SJ20(1000ea/cs)		VBFB24K/부리또보울용기몸통/PULP FIBER BOWL-24oz(300ea/cs)		VBFB30K/부리또보울용기몸통/PULP FIBER BOWL-30oz(500ea/cs)		VBFB40K/부리또보울용기몸통/PULP FIBER BOWL-40oz(500ea/cs)									
															
주문단위	CASE	입수량	1000	주문단위	CASE	입수량	300	주문단위	CASE	입수량	500	주문단위	CASE	입수량	500
															
85139018		85539002		85539003		85539004									
IMPERIAL	85539005	GSK	95562215	GSK	95562216	GSK	95562217								
VBFBPETL/부리또보울용기플래트드/PET FLAT LID FOR 24,30,40 OZ BOWL-clear(500ea/cs)		찜탕용기몸통(대)/HOT POT FOOD ROUND CONTAINER BODY LARGE-14x4H"/clear(100ea/cs)		찜탕용기은박접시(대)/HOT POT FOOD ROUND SILVER PAN LARGE-12.5x2H"/silver(100ea/cs)		찜탕용기뚜껑(대)/HOT POT FOOD ROUND CONTAINER LID LARGE-13.75"/clear(100ea/cs)									
															
주문단위	CASE	입수량	500	주문단위	CASE	입수량	100	주문단위	CASE	입수량	100	주문단위	CASE	입수량	100
															
85539005		95562215		95562216		95562217									
GSK	95562218	GSK	95562219	GSK	95562220										
찜탕용기몸통(중)/HOT POT FOOD ROUND CONTAINER BODY MEDIUM-13X4H"/clear(100ea/cs)		찜탕용기은박접시(중)/HOT POT FOOD ROUND SILVER PAN MEDIUM-11x2H"/silver(100ea/cs)		찜탕용기뚜껑(중)/HOT POT FOOD ROUND CONTAINER LID MEDIUM-12.4"/clear(100ea/cs)											
															
주문단위	CASE	입수량	100	주문단위	CASE	입수량	100	주문단위	CASE	입수량	100				
															
95562218		95562219		95562220											

WRAP & PAPER



IMPERIAL	85151152	IMPERIAL	85151151	IMPERIAL	85151155	GSK	95151107
12DISPFLM/커팅 홈랩/CUTTING HOME WARP/ DISP FILM BORDEN-12"x2000'		307005/홈랩/CLING WRAP/ VB WRAP-12x2000'		307006/홈랩/CLING WRAP- 18"x2000'		하이퍼포먼스래핑필름/HIGH PERFORMANCE MEAT FILM- 4012'x18"/17micron/72gauge	
							
주문단위	EACH	입수량	1	주문단위	EACH	입수량	1
							
95151152		95151151		95151155		95151107	
IMPERIAL	81000031	IMPERIAL	81000030	IMPERIAL	85181230	GSK	92098008
1215DEL/왁스페이퍼/WET WAX PAPER-12x15"(50ea/cs)		F1215NUP/왁스페이퍼/DRY WAX PAPER-12x15"(10lb/5pk/cs)		1230MP/스테이크페이퍼/STEAK PAPER-12"x30"(1000ea/cs)		28-PM-68 FILM/자동 Wrapping Machine 호환 기계 필름/MEAT FILM- 16"x4500'(RGF/EDS/AYAMYOOK)	
							
주문단위	CASE	입수량	50	주문단위	CASE	입수량	50
주문단위	CASE	입수량	1000	주문단위	EACH	입수량	1
							
81000031		81000030		85181230		92098008	
IMPERIAL	85180010	IMPERIAL	85180015	IMPERIAL	85180006	GSK	95151907
FLOW10/왁스페이퍼/WAX PAPER LOGAN WRAP- 10x10.75"(6000ea/cs)		VB1510/왁스페이퍼/LOGAN WRAP WAX PAPER- 15x10.75"(6000ea/cs)		VB610/왁스페이퍼/MORPAK WAX PAPER-6x10.75"(6000ea/cs)		GSK팔렛랩/GSK HIGH AUALITY STRETCH PALLET WRAP- 1000'x18"(3'cone)/75gauge(4rl/cs)	
							
주문단위	CASE	입수량	6000	주문단위	CASE	입수량	6000
주문단위	CASE	입수량	6000	주문단위	CASE	입수량	4
							
85180010		85180015		85180006		95151907	

CLOTHES

- H MART UNIFORM



GSK	97999865	GSK	97999866	GSK	97999867	GSK	97999868
SW-G-XS/H-MART유니폼조끼 /H-MART UNIFORM VEST- xsmall/green(15ea/pk)		SW-G-S/H-MART유니폼조끼 /H-MART UNIFORM VEST- small/green(15ea/pk)		SW-G-M/H-MART유니폼조끼 /H-MART UNIFORM VEST- medium/green(15ea/pk)		SW-G-L/H-MART유니폼조끼 /H-MART UNIFORM VEST- large/green(15ea/pk)	
							
주문단위	PACK	입수량	15	주문단위	PACK	입수량	15
							
97999865		97999866		97999867		97999868	
GSK	97999869	GSK	97999872	GSK	97999873	GSK	97999860
SW-G-XL/H-MART유니폼조끼 /H-MART UNIFORM VEST- xlarge/green(15ea/pk)		SW-G-2XL/H-MART유니폼조끼 /H-MART UNIFORM VEST- 2xlarge/green(5ea/pk)		SW-G-3XL/H-MART유니폼조끼 /H-MART UNIFORM VEST- 3xlarge/green(5ea/pk)		SW-O-XS/H-MART유니폼조끼 /H-MART UNIFORM VEST- xsmall/orange(15ea/pk)	
							
주문단위	PACK	입수량	15	주문단위	PACK	입수량	5
							
97999869		97999872		97999873		97999860	
GSK	97999861	GSK	97999862	GSK	97999863	GSK	97999864
SW-O-S/H-MART유니폼조끼 /H-MART UNIFORM VEST- small/orange(15ea/pk)		SW-O-M/H-MART유니폼조끼 /H-MART UNIFORM VEST- medium/orange(15ea/pk)		SW-O-L/H-MART유니폼조끼 /H-MART UNIFORM VEST- large/orange(15ea/pk)		SW-O-XL/H-MART유니폼조끼 /H-MART UNIFORM VEST- xlarge/orange(15ea/pk)	
							
주문단위	PACK	입수량	15	주문단위	PACK	입수량	15
							
97999861		97999862		97999863		97999864	

GSK		97999870		GSK		97999871	
SW-O-2XL/H-MART유니폼조끼 /H-MART UNIFORM VEST- 2xlarge/orange(5ea/pk)				SW-O-3XL/H-MART유니폼조끼 /H-MART UNIFORM VEST- 3xlarge/orange(5ea/pk)			
							
주문단위	PACK	입수량	5	주문단위	PACK	입수량	5
 97999870				 97999871			

CLOTHES

- 조리용



GSK	95399006	GSK	95399007	GSK	95399009	GSK	95399013
화이트조리용유니폼(7부)/CHEF COAT HALF SLEEVE UNIFORM—xlarge/white		화이트조리용유니폼(7부)/CHEF COAT HALF SLEEVE UNIFORM—2xlarge/white		화이트허리앞치마/FABRIC WAIST APRON/white		블랙차이나조리용유니폼(긴팔)/CHINESE STYLE CHEF COAT LONG SLEEVE UNIFORM—xlarge/black	
주문단위	EACH	입수량	1	주문단위	EACH	입수량	1
GSK	95399014	GSK	95399008	IMPERIAL	85429001	IMPERIAL	85429002
블랙차이나조리용유니폼(긴팔)/CHINESE STYLE CHEF COAT LONG SLEEVE UNIFORM—2xlarge/black		블랙허리앞치마/FABRIC WAIST APRON/black		2846APRON/일회용앞치마/DISPOSABLE APRON—28"x46"/white/(500ea/cs)		DAV08/비닐앞치마/VINYL APRON 1.25MIL—24"x42"/white/(12ea/cs)	
주문단위	EACH	입수량	1	주문단위	CASE	입수량	500
GSK	96313305	GSK	96313304	IMPERIAL	85123456	IMPERIAL	85562001
Apron—4010/한국앞치마/KOREA PVC APRON—navy		Apron—4041/고무앞치마/RUBBER APRON		BUFFON21/그물망모자/HAIR NET—21"white/nylon(500ea/cs)		종이위생모자/PAPER OVERSEAS CAP/WHITE (CAP)—(1000ea/cs)	
주문단위	EACH	입수량	1	주문단위	CASE	입수량	500

IMPERIAL	85404449	GSK	95399004	GSK	95399010	GSK	95590104
그물머리망 / NYLON HAIRNETS - black (144ea/cs)		화이트캡조리용모자 / CHEF CAP / white		블랙조리용두건 / CHEF BANDANA / black (10ea/pk)		M5 / 플라스틱 위생마스크 / PLASTIC MASK / MASCARE - (5ea/pk)	
							
주문단위	CASE	입수량	144	주문단위	EACH	입수량	1
주문단위	PACK	입수량	10	주문단위	PACK	입수량	5
							
85404449		95399004		95399010		95590104	
IMPERIAL	85562101	GSK	99535313	GSK	99535312	IMPERIAL	85590112
DSWP18 / 일회용비닐팔토시 / SLEEVE PROTECTOR POLY - 18" / white (1000ea/cs)		정육수산부직원가운 / HMART WHITE GOWN - LARGE SIZE - WHITE		정육수산부직원가운 / HMART WHITE GOWN - MEDIUM SIZE - WHITE		DSFM300MVBX / 일회용페이셜마스크 / FACE MASK 3PLY NON MEDICAL - blue (50ea/cs)	
							
주문단위	CASE	입수량	1000	주문단위	EACH	입수량	1
주문단위	CASE	입수량	50	주문단위	EACH	입수량	1
							
85562101		99535313		99535312		85590112	

CLOTHES

- 방한용



GSK	99535434			GSK	99535433			GSK	99562115			GSK	99535420		
0045RBLK/방한모/WINTER CAP—regular/black				0049RBLK/방한목토시/WINTER NECK GAITER—regular/black				0318/ 방한장갑/CHILLBREADKER GLOVE				0343RNAV2XLG/IRON-TUFF방한복 자켓/WINTER JACKET—regular/2xlarge/navy			
															
주문단위	EACH	입수량	1	주문단위	EACH	입수량	1	주문단위	PAIR	입수량	1	주문단위	EACH	입수량	1
															
99535434				99535433				99562115				99535420			

GSK	99535418			GSK	99535414			GSK	99535413			GSK	99535419		
0343RNAVSMALL/IRON-TUFF방한복 자켓/WINTER JACKET—regular/small/navy				0343RNAVMED/IRON-TUFF방한복 자켓/WINTER JACKET—regular/medium/navy				0343RNAVLAR/IRON-TUFF방한복 자켓/WINTER JACKET—regular/large/navy				0343RNAVXLG/IRON-TUFF방한복 자켓/WINTER JACKET—regular/xlarge/navy			
															
주문단위	EACH	입수량	1	주문단위	EACH	입수량	1	주문단위	EACH	입수량	1	주문단위	EACH	입수량	1
															
99535418				99535414				99535413				99535419			

GSK	99535422			GSK	99535423			GSK	99535430			GSK	99535369		
0343TNAVLLAR/IRON-TUFF방한복 자켓/WINTER JACKET—tall/large/navy				0343TNAVXLG/IRON-TUFF방한복 자켓/WINTER JACKET—tall/xlarge/navy				0925RNAVSMALL/ECONO-TUFF보온복 자켓/WINTER JACKET—regular/small/navy				0925RNAVMED/ECONO-TUFF보온복 자켓/WINTER JACKET—REG—medium/navy			
															
주문단위	EACH	입수량	1	주문단위	EACH	입수량	1	주문단위	EACH	입수량	1	주문단위	EACH	입수량	1
															
99535422				99535423				99535430				99535369			

GSK	99535370	GSK	99535431	GSK	99535432	GSK	99535459
0925RNAV/LAR/ECONO-TUFF보온복 자켓/WINTER JACKET-REG-large/navy		0925RNAV/XLG/ECONO-TUFF보온복 자켓/WINTER JACKET-regular/xlarge/navy		0925RNAV/2XLG/ECONO-TUFF보온복 자켓/WINTER JACKET-regular/2xlarge/navy		0925RNAV/3XLG/ECONO-TUFF보온복 자켓/WINTER JACKET-regular/3xlarge/navy	
							
주문단위	EACH	입수량	1	주문단위	EACH	입수량	1
							
99535370		99535431		99535432		99535459	

GSK	99535425	GSK	99535426	GSK	99535412	GSK	99535411
0385RNAV/SMALL/IRON-TUFF방한복 오버롤바지/FREEZER IRON TUFF OVERALL PANTS-regular/small/navy		0385RNAV/MED/IRON-TUFF방한복 오버롤바지/WFREEZER IRON TUFF OVERALL PANTS-regular/medium/navy		0386RNAV/LAR/방한복오버롤바지/FREEZER IRON TUFF OVERALL PANTS-regular/large/navy		0386RNAV/XLG/방한복오버롤바지/FREEZER IRON TUFF OVERALL PANTS-regular/xlarge/navy	
							
주문단위	EACH	입수량	1	주문단위	EACH	입수량	1
							
99535425		99535426		99535412		99535411	

GSK	99535410	GSK	99535409	GSK	97000414	GSK	99535435
0386RNAV/2XL/방한복오버롤바지/FREEZER IRON TUFF OVERALL PANTS-regular/2xlarge/navy		0386RNAV/3XLG/방한복오버롤바지/FREEZER IRON TUFF OVERALL PANTS-regular/3xlarge/navy		S-21701-2X/방한복오버롤바지/COLD STORAGE OVERALLS-2xlarge/blue		0195RHV/LAR/우비상하의세트/MIDWEIGHT RAINWEAR	
							
주문단위	EACH	입수량	1	주문단위	EACH	입수량	1
							
99535410		99535409		97000414		99535435	

GSK		99535436	
0198RHVLXLG / 야광 조끼 / SAFETY VEST - xlarge			
			
주문단위	EACH	입수량	1
 99535436			

BOOTS











GSK	99599001	GSK	99599002	GSK	99599003	GSK	99599004
RBC-SW11-7/금해여름장화 /SUMMER LONG BOOTS- us7/250cm/navy		RBC-SW11-8/금해여름장화 /SUMMER LONG BOOTS- us8/260cm/navy		RBC-SW11-9/금해여름장화 /SUMMER LONG BOOTS- us9/270cm/navy		RBC-SW11-10/금해여름장화 /SUMMER LONG BOOTS- us10/280cm/navy	
							
주문단위	EACH	입수량	1	주문단위	EACH	입수량	1
							
99599001		99599002		99599003		99599004	
GSK	99599005	GSK	99599006	GSK	99599011	GSK	99599012
RBC-SW11-11/금해여름장화 /SUMMER LONG BOOTS- us11/290cm/navy		RBC-SW11-12/금해여름장화 /SUMMER LONG BOOTS- us12/300cm/navy		RBC-ULTRA-7/금해겨울장화 /WINTER LONG BOOTS w/CUFFS-us7/250cm/black		RBC-ULTRA-8/금해겨울장화 /WINTER LONG BOOTS w/CUFFS-us8/260cm/black	
							
주문단위	EACH	입수량	1	주문단위	EACH	입수량	1
							
99599005		99599006		99599011		99599012	
GSK	99599013	GSK	99599014	GSK	99599015	GSK	99599016
RBC-ULTRA-9/금해겨울장화 /WINTER LONG BOOTS w/CUFFS-us9/270cm/black		RBC-ULTRA-10/금해겨울장화 /WINTER LONG BOOTS w/CUFFS-us10/280cm/black		RBC-ULTRA-11/금해겨울장화 /WINTER LONG BOOTS w/CUFFS-us11/290cm/black		RBC-ULTRA-12/금해겨울장화 /WINTER LONG BOOTS w/CUFFS-us12/300cm/black	
							
주문단위	EACH	입수량	1	주문단위	EACH	입수량	1
							
99599013		99599014		99599015		99599016	

GLOVES



GSK	93061001	GSK	93061002	IMPERIAL	85561189	GSK	93061005
코팅장갑/COATING GLOVES-10*36-red/73031103(360ea/cs)		면장갑/COTTON GLOVES-10*36-white/73031202(360ea/cs)		FED201/일회용고무비닐장갑/DISPOSABLE GLOVE POWDER FREE VINYL/-small(1000ea/cs)		마미손고무장갑/MAMISON RUBBER GLOVES-xlarge/red/73033105(100ea/cs)	
							
주문단위	CASE	입수량	360	주문단위	CASE	입수량	360
							
93061001		93061002		85561189		93061005	

GSK	95561214	GSK	95561217	GSK	95561216	GSK	95561215
SNM50020../블루니트릴장갑/BLUE NITRILE DISPOSABLE NITRILE PF GLOVE POWDER FREE-x-large(100ea/10pk/cs)		SNM50015../블루니트릴장갑/BLUE NITRILE DISPOSABLE NITRILE PF GLOVE POWDER FREE-large(100ea/10pk/cs)		SNM50010../블루니트릴장갑/BLUE NITRILE DISPOSABLE NITRILE PF GLOVE POWDER FREE-medium(100ea/10pk/cs)		SNM50005../블루니트릴장갑/BLUE NITRILE DISPOSABLE NITRILE PF GLOVE POWDER FREE-small(100ea/10pk/cs)	
							
주문단위	CASE	입수량	1000	주문단위	CASE	입수량	1000
							
95561214		95561217		95561216		95561215	

GSK	96361002	GSK	96361003	GSK	96361004	GSK	96361005
BGCR/방검장갑/CUT RESISTANT GLOVES/LEVEL 5 PROTECTION-medium(12ea/cs)		BGCR/방검장갑/CUT RESISTANT GLOVES S LEVEL 5 PROTECTION FOOD GRADE(12ea/cs)		BGCR/방검장갑/CUT RESISTANT GLOVES L LEVEL 5 PROTECTION FOOD GRADE(12ea/cs)		BGCR/방검장갑/CUT RESISTANT GLOVES XL LEVEL 5 PROTECTION FOOD GRADE(12ea/cs)	
							
주문단위	CASE	입수량	12	주문단위	CASE	입수량	12
							
96361002		96361003		96361004		96361005	

CHEMICALS







GSK	95403127	GSK	95403124	IMPERIAL	85428017	IMPERIAL	85428018
CLOX30966/클로락스표백제 /CLOROXGERMICIDA BLEACH- 121oz(3btl/cs)		CHLOR-GLO/표백제/BLEACH DISINFECTANT SANITIZER- 1gal(4ea/cs)		E69-5/식기세척기용세제 /ECOLOGIC/DISH WASH MACHINE POT&PAN DETERGENT-5gal		E69-G/식기세척기용세제 /POT&PAN DETERGENT 1gal ECOLOGIC DISH WASH MACHINE(4ea/cs)	
							
주문단위	CASE	입수량	3	주문단위	CASE	입수량	4
							
95403127		95403124		85428017		85428018	
GSK	95629901	GSK	95407021	GSK	91007001	IMPERIAL	85507005
JOY/주방 세제/POT&PAN DETERGENT-38oz/yellow(8ea/cs)		10652/핑크식기세제/PINK POT N PAN DETERGENT SO KLEEN PINK LIQUID-1gal(4ea/cs)		QCC-132-1/퀄리티케미컬오브그 릴클리너/QUALITY CHEMICAL OVEN & GRILL CLEANER- 128oz/1gal(2ea/cs)		4INSPECT/기름 제거제 /DEGREASER-1gal(4ea/cs)	
							
주문단위	CASE	입수량	8	주문단위	CASE	입수량	4
							
95629901		95407021		91007001		85507005	
IMPERIAL	85408042	IMPERIAL	85621111	GSK	95403128	GSK	95407026
E2-G/기름 제거제/DEGREASER ECOLOGIC FOR DISH WASH MACHINE-1gal(4ea/cs)		C18-G/세네타이저세정제 /ECOLOGIC SANITIZER- 1gal(4ea/cs)		새네타이저/GREEN KEY SANITIZER-1gal(4ea/cs)		10994/핑크핸드솜/PINK STAR HAND SOAP-1gal(4ea/cs)	
							
주문단위	CASE	입수량	4	주문단위	CASE	입수량	4
							
85408042		85621111		95403128		95407026	

IMPERIAL	85402023	GSK	95407025	GSK	95407029	GSK	95407028
4DM/바닥청소세제/DAMP MOP CLEANER-1 GAL(4ea/cs)		파인바닥 청소제/PINE DEODORANT FLOOR CLEANER-1gal(4ea/cs)		SD1182701/바닥광택제/LUSTER PLUS,NO RINSE NEUTRAL FLOOR CLEANER-1gal(4ea/cs)		21001/윈도우클리너/WINDOW CLEANER-1gal(4ea/cs)	
							
주문단위	CASE	입수량	4	주문단위	CASE	입수량	4
							
85402023		95407025		95407029		95407028	
IMPERIAL	85408045	IMPERIAL	85408031	IMPERIAL	85503001	IMPERIAL	85408051
E45-G/드립핑/DRAIN&ODOR TREATMENT-1gal(4ea/cs)		90940/윈덱스유리용클리너/WINDEX GLASS CLEANER-1 gal(4ea/cs)		F00044/스프레이유리클리너/VB SPRAY GLASS CLEANER AMMONIATED-32oz (12ea/cs)		CFCLBR50/가루세제/POWDER DETERGENT	
							
주문단위	CASE	입수량	4	주문단위	CASE	입수량	12
							
85408045		85408031		85503001		85408051	
주문단위	EACH	입수량	1				

FRESHENER & SCRUBBER











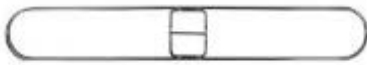

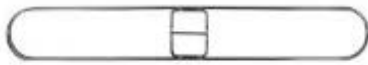
IMPERIAL	85412001			IMPERIAL	85428501			IMPERIAL	85428502			IMPERIAL	85629902		
USCD/화장실나프탈렌/URINAL SCREEN W/DEOD BLOCK(12ea/cs)				SS/철수세미/STAINLESS STEEL SPONGE SCRUBBER(72ea/cs)				96 VB96MSP/청수세미/GREEN SPONGE SCRUBBER-6"x9"/green(20ea/cs)				17001205/방향제리필/AIR FRESHENER REFILL-6.6oz/vanilla(12ea/cs)			
															
주문단위	CASE	입수량	12	주문단위	CASE	입수량	72	주문단위	CASE	입수량	20	주문단위	CASE	입수량	12
															
85412001				85428501				85428502				85629902			









IMPERIAL	85629905			IMPERIAL	85629906		
17001236/방향제리필/AIR FRESHENER REFILL-6.6oz/citrus orange(12ea/cs)				DSP1700/자동방향제기계 /AUTOMATIC AEROSOL DISPENSER-6.6oz			
							
주문단위	CASE	입수량	12	주문단위	EACH	입수량	1
							
85629905				85629906			

CLEANING



IMPERIAL	85139535	IMPERIAL	85402081	IMPERIAL	85139536	IMPERIAL	85402082
SN524/기름걸레프레임/DUST MOP FRAME-24"x5"/black/metal		DM245/기름걸레/DUST MOP HEAD-24"x5"		SN536/기름걸레프레임/DUST MOP FRAME-36"x5"/black/metal		DM365/기름걸레/DUST MOP HEAD-36"x5"	
							
주문단위	EACH	입수량	1	주문단위	EACH	입수량	1
							
85139535		85402081		85139536		85402082	

IMPERIAL	85402085	IMPERIAL	85402084	IMPERIAL	85402083	IMPERIAL	85402024
SN548/기름걸레프레임/DUST MOP FRAME-48"x5"/black/metal		DM485/기름걸레/DUST MOP HEAD-48"x5"		SNSTK/기름걸레자루/DUST MOP HANDLE-60"		97156/마포걸레/MAXICLEAN MOP BLUE-24oz	
							
주문단위	EACH	입수량	1	주문단위	EACH	입수량	1
							
85402085		85402084		85402083		85402024	

IMPERIAL	85402032	IMPERIAL	85402091	IMPERIAL	85402099	IMPERIAL	85401010
32DDMP/마포#32/COTTON MOP HEAD		608HANDLE/마포자루/MOPSTICK FIBERGLASS		226311YW/마포짜는통/206-31YW MOP BUCKET-26qt		91351/빗자루/DUO-SWEEP BROOM-13x48"	
							
주문단위	EACH	입수량	1	주문단위	EACH	입수량	1
							
85402032		85402091		85402099		85401010	

IMPERIAL	85406016			IMPERIAL	85401013			IMPERIAL	85404022			IMPERIAL	85401017		
B452/쓰레받기/LOBBY DUST PAN-12"-SWIVEL				136STKB/물밀대&창고브러시 자루 /SQUEEGEE&BRUSH HANDLE-60"				96826/물밀대/WATER SQUEEGEE HEAD, -22"(136STK/HEAD ONLY)				24GB/창고브러시/GARAGE BRUSH-24"(136STK/GARAGE CLEANING/10824GB)			
															
주문단위	EACH	입수량	1	주문단위	EACH	입수량	1	주문단위	EACH	입수량	1	주문단위	EACH	입수량	1
															
85406016				85401013				85404022				85401017			

IMPERIAL	85401018			IMPERIAL	85401026			IMPERIAL	85404445			IMPERIAL	85404446		
18GB/창고브러시/GARAGE BRUSH-18"(10818BRM)				BR-605-10/데크브러쉬/DECK BRUSH-10",HANDLE: 125STK				8323GY/23GAL쓰레기통/SLIM JIM 23 GAL TRASH CAN- 30.5x19.75x11.5"/gray/rectangle				7325GRY/쓰레기통뚜껑/LID GRAY SWING -23gal			
															
주문단위	EACH	입수량	1	주문단위	EACH	입수량	1	주문단위	EACH	입수량	1	주문단위	EACH	입수량	1
															
85401018				85401026				85404445				85404446			

IMPERIAL	85404432			IMPERIAL	85404447			IMPERIAL	85404444			IMPERIAL	85404441		
3200GY/쓰레기통/TRASH CAN- 32GAL				3201GY/쓰레기통뚜껑/TRASH CAN LID,32 GAL- RAY/ROUND/3200GY/CONTINENTAL,(1/CS)-2631RM				4444GY/쓰레기통/TRASH CAN- 44gal-gray- round- 2645RM/CONTINENTAL				264560/쓰레기통뚜껑 /RUBBERMAID RESIN FLAT LID/gray/round/body:4444GY			
															
주문단위	EACH	입수량	1	주문단위	EACH	입수량	1	주문단위	EACH	입수량	1	주문단위	EACH	입수량	1
															
85404432				85404447				85404444				85404441			

IMPERIAL	85406031	GSK	97999923	GSK	98000300	GSK	95408066
97000/쓰레기통바퀴받침/TRASH CAN DOLLY ROUND-gray		H-1336/재니터카트/Rubbermaid Standard Janitor Cart- 22" X 46" X 38"		H-6089/청소용품홀더/QUICK ADJUSTABLE MOP BROOM HOLDER-20"		H-7867BL/청소도구보관대/GARAGE TOOL HOLDERS/black	
							
주문단위	EACH	입수량	1	주문단위	EACH	입수량	1
							
85406031		97999923		98000300		95408066	

DISPENSER

- TOWEL & REFILL



GSK	95231092	GSK	95623003	IMPERIAL	85512004	IMPERIAL	85538005
54338A/핸드타올디스펜서/Vista PUSH LEVER DISPENSER— 12.75Wx14.25H"/black		78000003/핸드페이퍼타올/HAND PAPER TOWEL— 8"x800"/white(6rl/cs)		346357/자동핸드타올디스펜서 /VICTORIA BAY AUTOMATED PAPER ROLL TOWEL DISPENSER— 12.9x9x16"(85538005호환)		346358/핸드페이퍼타올/VICTORIA BAY RECYCLED PAPER TOWEL ROLL FOR 346357— 8"x1150ft/white(6rolls/cs)(8551200 4호환)	
							
주문단위	EACH	입수량	1	주문단위	CASE	입수량	6
							
95231092		95623003		85512004		85538005	
IMPERIAL	85231008	GSK	95231009	IMPERIAL	85538003	GSK	95238005
R2000TBK/싱글화장실휴지디스펜서/ SAN JAMAR SINGLE PLASTIC TOILET PAPER DISPENSER JUMBO 9"—16.75Wx12.25Lx5.25H"/black		161661/화장실휴지(대)디스펜서 /JRT JR TWIN TOILET TISSUE DISPENSER—9"		VBJT2650/화장실휴지 /BATHROOM TISSUE 2 PLY EMBOSSED JUNIOR ROLL for 161661—9"x800'(12ea/cs)		1000011/롤페이퍼타올 /HAWTHORN KITCHEN ROLL PAPER POWEL—7.8"x11"(30rl/cs)	
							
주문단위	EACH	입수량	1	주문단위	CASE	입수량	12
							
85231008		95231009		85538003		95238005	
GSK	95923001	GSK	95230049	GSK	95738001	IMPERIAL	85538006
프리미엄롤페이퍼타올/ PREMIUM PAPER TOWEL—11"x 5.5" (6rl/cs)		123064/디너냅킨/DINNER NAPKIN FOLD MARKETPRO — 15"x17"/white/2PLY(150ea/20pk /cs)		JLF30200/디스펜서리필용냅킨 /NAPKIN LOWFOLD JR BELLEMARQUE— white/6.5"Lx12"W(500ea/16pk/cs)		GOJO951704/항균티슈/HAND SANITIZING WIPES(1700ea/4rl/cs)	
							
주문단위	CASE	입수량	6	주문단위	CASE	입수량	3000
							
95923001		95230049		95738001		85538006	









GSK		95231093	
166188 / 핸드페이퍼타올 / TOWEL ROLL UNIVERSAL - 8x700' / white(6rl / cs)			
			
주문단위	CASE	입수량	6
 95231093			

DISPENSER

- HANDSOAP & REFILL



IMPERIAL	85408021			IMPERIAL	85408023			IMPERIAL	85621102			IMPERIAL	85507009		
GOJO910612/손닦는물비누리필 /GOJO912812 HAND SOAP- 800ml(12ea/cs)				AZU1L/손닦는거품비누리필 /FOAMING HAND SOAP- 1L(6ea/cs)				539202/손세정제리필/HAND SANITIZER PURELL/MANUAL GEL TYPE-1200ml(2ea/cs)				L05575/폼핸드워시리필/VICTORIA BAY 7642-02-H6C00RR PLUM ANTIBA FOAM HANDWASH FOR L05571- 1200ml(2ea/cs)(85512003호환)			
															
주문단위	CASE	입수량	12	주문단위	CASE	입수량	6	주문단위	CASE	입수량	2	주문단위	CASE	입수량	2
															
85408021				85408023				85621102				85507009			





GSK	95512009			IMPERIAL	85512010			GSK	95512006			GSK	95512007		
L05572/핸드솜수동디스펜서/VB HAND SOAP MANUAL DISPENSER FOR LO5501-white				L05501/핸드솜수동리필/VB HAND SOAP MANUAL REFILL- 1200ml(4ea/cs)				7218DS/퓨렐자동핸드세니타이저 스탠드디스펜서/PURELL AUTO HAND SANITIZER FLOOR STAND DISPENSER FOR PURELL775302				퓨렐자동핸드세니타이저디스펜서 /PURELL AUTO HAND SANITIZER WALL-MOUNT DISPENSER FOR PURELL775302			
															
주문단위	EACH	입수량	1	주문단위	CASE	입수량	4	주문단위	EACH	입수량	1	주문단위	EACH	입수량	1
															
95512009				85512010				95512006				95512007			

IMPERIAL	85512008		
PURELL775302/퓨렐자동핸드세니 타이저리필/PURELL AUTO HAND SANITIZER REFILL-1200ml(2ea/cs)			
			
주문단위	CASE	입수량	2
			
85512008			

DISPENSER

- 우산 & 우산비닐 & 우산비닐 디스펜서



GSK				99535318				GSK				98117050				IMPERIAL				86340203				IMPERIAL				86340202																																			
SW-LU/H-MART 로고장우산 /EXTENDABLE UMBRELLA H- MART LOGO TF-1360 AUTO HANDLE--orange&white/F9022-- 55.5"(12ea./pk)																GSK WEST/B00BRNF3QU/우산비 닐백/WET UMBRELLA BAGS--full size/Polyethylene(1000ea./pk)																GSK HQ/RS1000S/우산 비닐 /UMBRELLA BAG/FULL SIZE POLY(3000ea./cs)																RS1000/우산비닐디스펜서 /UMBRELLA WRAPPER DISPENSER FULL SIZE POLY															
																																																															
주문단위				PACK				입수량				12				주문단위				PACK				입수량				1000				주문단위				CASE				입수량				3000				주문단위				EACH				입수량				1			
																																																															
99535318																98117050																86340203																86340202															

LABEL & GUN



GSK	95202271	GSK	95202272	GSK	95202273	GSK	95202274								
40724/디자인청과저울레이블 /DESIGN PRODUCE SCALE LABEL— 2.25x3x1.5"/green(380ea/24rl/cs)		디자인생선저울레이블/DESIGN FISH SCALE LABEL— 2.25x3x1.5"/blue(380ea/24rl/cs)		디자인반찬저울레이블/DESIGN RTC SCALE LABEL— 2.25x3x1.5"/purple(380ea/24rl/cs)		디자인 정육 저울레이블/DESIGN MEAT SCALE LABEL— 2.25x3.625x1.5"/green and red(284ea/24rl/cs)									
															
주문단위	CASE	입수량	9120	주문단위	CASE	입수량	9120	주문단위	CASE	입수량	9120	주문단위	CASE	입수량	6816
															
95202271		95202272		95202273		95202274									
GSK	95202275	GSK	95202270	GSK	95202276	GSK	95202269								
디자인제과저울레이블, DESIGN BAKERY SCALE LABEL— 2.25x4.75x1.5"/brwon(240cs/rl)(24rl /cs)		유페이프라이스레이블/YOU PAY PRICE THERMAL LABEL(for houseware)— 3x1.125"/white(400ea/30rl/cs)		41212/유페이프라이스레이블 /YOU PAY PRICE THERMAL LABEL— 3x1.125"/yellow(400ea/30rl/cs)		MA지역프라이스레이블/MA STORE UNIT PRICE THERMAL LABEL(MA only)— 3x1.125"/orange&yellow(400ea/30rl /cs)									
															
주문단위	CASE	입수량	5760	주문단위	CASE	입수량	12000	주문단위	CASE	입수량	12000	주문단위	CASE	입수량	12000
															
95202275		95202270		95202276		95202269									
GSK	96292901	GSK	95202286	GSK	95222071	GSK	95222075								
SW-PLC/플라스틱프라이스레이블 커버/SHELF STRIP PRICE LABEL PLASTIC COVER(250ea/pk)		유기농레이블/ORGANIC LABEL,1— 3/4" DIA(1000ea/rl)		패밀리팩레이블/FAMILY PACK LABEL/1—1/4" DIA(1000ea/rl)		41013/샤브샤브 레이블/SHABU SHABU LABEL/1—1/4" DIA(1000ea/rl)									
															
주문단위	PACK	입수량	250	주문단위	ROLL	입수량	1000	주문단위	ROLL	입수량	1000	주문단위	ROLL	입수량	1000
															
96292901		95202286		95222071		95222075									

GSK	95402381	GSK	95402430	GSK	95402431	GSK	95402442
정육부장조림용레이블/SLOW COOK-1-1/4" DIA(1000ea/rl)		정육부구이용레이블/GRILLING LABEL,1-1/4"(1000ea/rl)		정육부국거리용레이블/SOUP LABEL-1-1/4" DIA(1000ea/rl)		정육부찜탕용레이블/SLOW COOK 찜탕용 LABEL-1-1/4"DIA(1000ea/rl)	
							
주문단위	ROLL	입수량	1000	주문단위	ROLL	입수량	1000
							
95402381		95402430		95402431		95402442	

GSK	95402443	GSK	95402498	GSK	95402445	GSK	95202012
정육부불고기용레이블/BULGOGI LABEL-1-1/4" DIA(1000ea/rl)		할랄레이블/HALAL LABEL-(1000ea/rl)		41369/매운맛레이블/SPICY LABEL-1-1/4" DIA(1000ea/rl)		데리야끼레이블/TERIYAKI LABEL 1.75" DIA/Brown(1000ea/rl)	
							
주문단위	ROLL	입수량	1000	주문단위	ROLL	입수량	1000
							
95402443		95402498		95402445		95202012	

GSK	95202013	GSK	95222105	GSK	95222106	GSK	95222107
화이트레이블/FAJITA LABEL 1.75" DIA/Green(1000ea/rl)		수산부자반생선레이블/SEAFOOD DEPT SALTED FISH LABEL-3x2.2"/Gold(1000/RL)		수산부한국산레이블/SEAFOOD DEPT MADE IN KOREA LABEL-1.5x2.6"/Blue(500ea/rl)		수산부핫팟레이블/SEAFOOD DEPT HOT POT LABEL-2.2x4"/Red(500ea/rl)	
							
주문단위	ROLL	입수량	1000	주문단위	ROLL	입수량	500
							
95202013		95222105		95222106		95222107	

GSK	95222039	GSK	95202287	IMPERIAL	95222023	GSK	95222040
흑돈 레이블(GBK),BERKSHIRE LABEL,1-3/4"DIA(1000ea/rl)		와규비프레이블/WAGYU BEEF LABEL,1-3/4" DIA(1000ea/rl)		C4084450001/정육부엡거스레이블 / CERTIFIED ANGUS BEEF LABEL(1000ea/rl)		건조숙성소고기레이블/DRY AGED BEEF LABEL-2X2"(1000ea/rl)	
							
주문단위	ROLL	입수량	1000	주문단위	ROLL	입수량	1000
							
95222039		95202287		95222023		95222040	
GSK	95222029	IMPERIAL	85222022	GSK	95202010	GSK	95202283
NEWPRIME/USDA프라임스티커 /USDA PRIME LABEL-1-1/2x1-1/2"(1000ea/rl)		US775/정육부초이스레이블 /USDA CHOICE SHIELD LABEL-1-1/4DIA(500ea/rl)		후르츠메들리레이블/FRUIT MEDLEY PRODUCE MIX FRUIT LABEL-4.75" x 4.75"(500ea/rl)		석류레이블/POMERGRANATE LABEL(1000ea/rl)	
							
주문단위	ROLL	입수량	1000	주문단위	ROLL	입수량	500
							
95222029		85222022		95202010		95202283	
GSK	95202284	GSK	95202285	GSK	95222101	GSK	95222102
후지사과레이블/FUJI APPLE LABEL/(1000ea/rl)		신고배레이블/SINGO PEAR LABEL/(1000ea/rl)		베스트셀러레이블/BEST SELLER LABEL-2.2x2.2"/Red(500ea/rl)		매니저스페셜레이블/SEAFOOD DEPT MANAGER SPECIAL LABEL-2.4x1.9"/Purple(1000ea/rl)	
							
주문단위	ROLL	입수량	1000	주문단위	ROLL	입수량	500
							
95202284		95202285		95222101		95222102	

GSK	95222072	GSK	95222073	GSK	95222074	GSK	95202008
41016/프라이스다운레이블/PRICE DOWN LABEL,1-1/4"DIA(1000ea/rl)		41012/매니저스페셜레이블/MANAGER SPECIAL LABEL,1-1/4" DIA(1000ea/rl)		41014/주간세일레이블/WEEKLY SALE LABEL/1-1/4" DIA(1000ea/rl)		H-MART 40주년 기념 레이블/H-MART 40 YEARS ANNIVERSARY LABEL-2" DIA/red(1000ea/rl)	
							
주문단위	CASE	입수량	1000	주문단위	ROLL	입수량	1000
							
95222072		95222073		95222074		95202008	
GSK	94402001	IMPERIAL	85222001	GSK	95202277	GSK	95202011
B07D9R3RZV/파이널세일레이블/FINAL SALE LABEL w/NO RETURN, NO REFUND-1.5x1.5"/neon pink(300ea/rl)		CQ124/스페셜레이블/SPECIAL LABEL(1000ea/rl)		페이드스티커/PAID STICKER-51x16mm(1000ea/20rl/cs)		ARTBOX 페이드스티커/ARTBOX PAID STICKER-51x16mm(1000ea/rl)	
							
주문단위	ROLL	입수량	300	주문단위	ROLL	입수량	1000
							
94402001		85222001		95202277		95202011	
GSK	95202306	GSK	95202314	GSK	95202308	GSK	95202311
BEEF 75/25/소고기75%성분레이블/BEEF 75% NUTRITION FACTS LABEL/58x75mm(1000ea/rl)		BEEF 80/20/소고기80%성분레이블2023/BEEF 80% NUTRITION FACTS LABEL-58x75mm(1000ea/rl)		BEEF 90/10/소고기90%성분레이블/BEEF 90% NUTRITION FACTS LABEL-58x75mm(1000ea/rl)		PORK 70/30/돼지고기 70% 성분레이블,PORK 70% NUTRITION FACTS LABEL,58x75mm,FOR H-MART MEAT(1000ea/rl)	
							
주문단위	ROLL	입수량	1000	주문단위	ROLL	입수량	1000
							
95202306		95202314		95202308		95202311	

GSK	95202315	GSK	95202316	GSK	97003395	GSK	96900023								
PORK 80/20/돼지고기80%성분레이블2023/PORK 80% NUTRITION FACTS LABEL— 58x75mm(1000ea/rl)		PORK 90/10/돼지고기90%성분레이블2023/PORK 90% NUTRITION FACTS LABEL— 58x75mm(1000ea/rl)		H-1713/디짓테이크넘버시스템기계/DIGIT TAKE A NUMBER SYSTEM (WIRELESS)		107P-101164/POP레이블/PERFORATED SIGN AND LABEL PAPER— white/1.25"Hx2.5"L(24ea/1000sh/cs)									
															
주문단위	ROLL	입수량	1000	주문단위	ROLL	입수량	1000	주문단위	EACH	입수량	1	주문단위	CASE	입수량	24000
 95202315		 95202316		 97003395		 96900023									
GSK	96292902	GSK	96292903	GSK	95202016	GSK	95202017								
S-14461/스냅레이블홀더/SNAP-ON ABEL HOLDERS WITH INSERTS - 3"/-(25ea/pk)		S-14462/스냅레이블홀더/SNAP-ON ABEL HOLDERS WITH INSERTS-6"/(25ea/pk)		30%할인레이블/R30% OFF ROUND LABEL— 2"/yellow(1000ea/rl)(25rl/cs)		50%할인레이블/R50% OFF ROUND LABEL— 2"/apricot(1000ea/rl)(25rl/cs)									
															
주문단위	PACK	입수량	25	주문단위	PACK	입수량	25	주문단위	ROLL	입수량	1000	주문단위	ROLL	입수량	1000
 96292902		 96292903		 95202016		 95202017									
GSK	95212208	GSK	95402533	GSK	97999924	GSK	95402532								
S-7956W/흰색가격표레이블/MONARCH 1131 LABELS- 3/4 X 7/16"/-(20,000ea/cs)		S-7978W/가격레이블/MONARCH 1136 LABELS- 3/4"x5/8"/white(1750ea/8rl/cs)		H-991/레이블건/MONARCH 1131 LABEL GUN		H-4565/가격레이블건/MONARCH 1136 ALPHA/NUMERIC LABEL GUN - TWO LINE-monarch label 3/4"x5/8"/gray									
															
주문단위	CASE	입수량	20000	주문단위	CASE	입수량	8	주문단위	EACH	입수량	1	주문단위	EACH	입수량	1
 95212208		 95402533		 97999924		 95402532									

GSK		97003101		GSK		97003023		GSK		97999688		GSK		98100524	
H-992-ROLLER/레이블잉크롤러 /MONARCH 1130/1131/1136 LABEL GUN REPLACEMENT INK ROLLER/black				S-5542W/흰색가격표레이블 /MONARCH1110 LABELS- 3/4 X 3/8" -(17,000ea/cs				H-707/레이블건/MONARCH 1110 LABEL GUN				H-707/레이블건잉크롤러 /MONARCH 1110 LABEL GUN REPLACEMENT INK ROLLER			
															
주문단위	EACH	입수량	1	주문단위	CASE	입수량	17000	주문단위	EACH	입수량	1	주문단위	EACH	입수량	1
															
97003101				97003023				97999688				98100524			











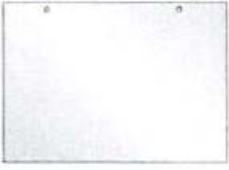
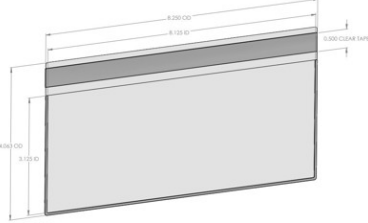
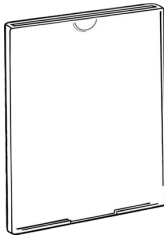





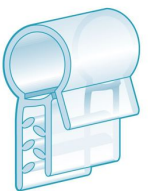
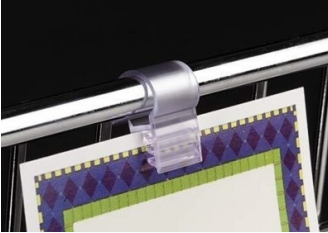

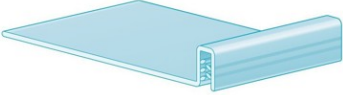

GSK		97003397		IMPERIAL		86319001	
H-1713/티켓롤/TAKE-A NUMBER SYSTEM TICKET- /white(15rl/cs)				MON-G/프라이스레이블건 /MONARCH LABEL GUN			
							
주문단위	CASE	입수량	15	주문단위	EACH	입수량	1
							
97003397				86319001			

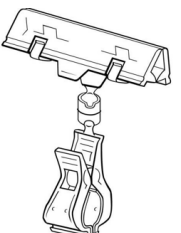

















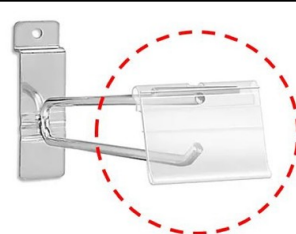



POP

- POP

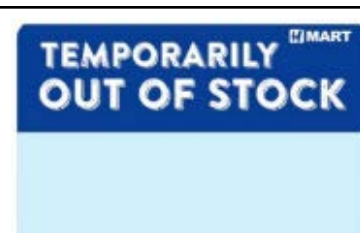











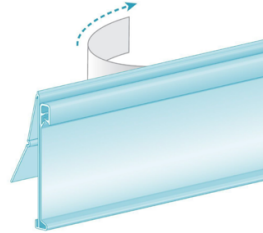



GSK	96900071	GSK	96900073	GSK	96900074	GSK	96900075								
P83/POP종이/POP PAPER WHITE-8x2.9"(9000ea/cs)		POP특수코팅절취용지(청과,냉장,냉동용)/POP SYNTHETIC PAPER W/PERFORATION AT 4"-8x3"/5ml(8800ea/cs)		POP오렌지컬러종이/POP COLOR PAPER COSMIC ORANGE-8 x 3"/89g,24lb(500ea/pk)		POP블루컬러종이/POP COLOR PAPER LUNAR BLUE-8 x 3"/89g,24lb(500ea/pk)									
															
주문단위	CASE	입수량	9000	주문단위	CASE	입수량	8800	주문단위	PACK	입수량	500	주문단위	PACK	입수량	500
															
GSK	96900076	W.B.	97003936	W.B.	97003937	W.B.	97002700								
POP옐로우컬러종이/POP COLOR PAPER SOLAR YELLOW-8 x 3"/89g,24lb(500ea/pk)		**ARAM 오더**WAU22651/ 오렌지칼라페이퍼/ASTROBRIGHT ORANGE COLOR PAPER-8 1/2 X 11"/Cosmic orange(500ea/pk)		**ARAM 오더**WAU22521/ 블루칼라페이퍼/ASTROBRIGHTS BLUE COLOR PAPER-8 1/2 X 11"/Lunar Blue(500ea/pk)		**ARAM 오더**WAU22531/ 옐로칼라페이퍼/ASTROBRIGHT YELLOW COLOR PAPER-8 1/2 X 11"/Solar yellow(500ea/pk)									
															
주문단위	PACK	입수량	500	주문단위	PACK	입수량	500	주문단위	PACK	입수량	500	주문단위	PACK	입수량	500
															
GSK	96900012	GSK	96900011	GSK	96292901	GSK	96900013								
PSP106440/POP종이커버/SMALL POP POCKET-4Lx3"H/small(50ea/pk)		PMP106441/POP종이커버/MEDIUM POP POCKET-8Lx3"H/medium(50ea/pk)		SW-PLC/플라스틱프라이스레이블커버/SHELF STRIP PRICE LABEL PLASTIC COVER(250ea/pk)		PLF 106835/POP커버대/LARGE POP POCKET-11"x8-1/2"(100ea/cs)									
															
주문단위	PACK	입수량	50	주문단위	PACK	입수량	50	주문단위	PACK	입수량	250	주문단위	CASE	입수량	100
															

GSK	96900014	GSK	96900003	GSK	96900084	GSK	96900151
PLT 106574/POP커버대/LARGE POP POCKET-11"x9"(100ea/cs)		110405/냉장고부착용POP비닐커버/VINYL POUCH W/ADHESIVE TAPE-clear/8"Lx3"H(25ea/pk)		2202278001/Letter Size POP사인홀더/WALL-MOUNT PLAIN SIGN HOLDER-8.5"Wx11"H(25ea/cs)		107608/사인프로텍터/PCTM1825 SIGN PROTECTOR-18"x25"/clear(10ea/cs)	
							
주문단위	CASE	입수량	100	주문단위	EACH	입수량	25
							
96900014		96900003		96900084		96900151	
GSK	96900062	GSK	96900061	GSK	96900041	GSK	96900021
1112148303/와이어사인홀더/301 SUPERGRIP WIRE FLUSH SIGN HOLDER-1"x3/4"(100ea/pk)		1112148301/와이어사인홀더/301 SUPERGRIP WIRE FLUSH SIGN HOLDER-1/2"x1"(100ea/pk)		POP플라스틱 자석프레임/LETTER PLASTIC FRAME MAGNETIC BASE-1"Wx1-1/4"Hx3"L(10ea/pk)		PLB183S104004/POP플라스틱프레임/LETTER PLASTIC FRAME BASE-5"Wx3"L(25ea/pk)	
							
주문단위	PACK	입수량	100	주문단위	PACK	입수량	10
							
96900062		96900061		96900041		96900021	
GSK	96900083	GSK	96900081	GSK	96900085	GSK	99700001
2805693105/POP포켓홀더클립/POCKET HOLDER CLIP-4x3"/small(25ea/pk)		2800342702/POP포켓&클립/POCKET WITH CLIP-7x5"		1601799801/POP클립/POCKET RING-white(100ea/pk)		SW-PMP/플라스틱자석프레임/PLASTIC LETTER SIZE SIGN FRAME W/ MAGNET HOLDER-8.5x11"/black(5ea/pk)	
							
주문단위	PACK	입수량	25	주문단위	EACH	입수량	1
							
96900083		96900081		96900085		99700001	

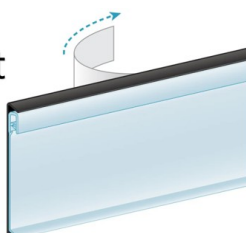

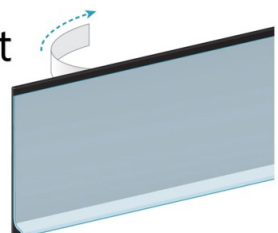



GSK	96900092	GSK	96900140	GSK	96340500	GSK	96340365								
SF-A-118.5/PLS스틸스텝프레임 스탠드/PLS POP LETTER STEEL STEM FRAME-11"x8-1/2"(10ea/cs)		PSSH-72/POP롱스탠드/POP PLL LETTER LONG STAND BASE AND TOP SET(2ea/cs)		SW-PSH/팔렛사인홀더 /ADJUSTABLE PALLET SIGN HOLDER-max50cm W/110to210cm H/25x31cm bottom/black(5ea/cs)		SW-SS/싸인스탠드/HEAVY DUTY SIGN STAND SNAP OPEN FRAME VERTICAL HORIZONTAL-8.5"x11"/34"to48"tall/black(5ea/cs)									
															
주문단위	CASE	입수량	10	주문단위	CASE	입수량	2	주문단위	CASE	입수량	5	주문단위	CASE	입수량	5
															
GSK	97001225	GSK	98215902	GSK	98215900	GSK	98215901								
H-5713BL/플로어스탠드사인홀더 /FLOOR STANDING SIGN HOLDER-SINGLE TIER-sign size 22x28"/61"H/black		KL-SWPT/스윙프라이스타그 /SWING PRICE TAG FOR DOUBLE LINE HOOK-transparent/40x80mm/1.6"x3.2"(10 0ea/pk)		KL-PT4F/프라이스타그/PRICE TAG-transparent/4f, 1,219mm(100ea/cs)		KL-PT3F/프라이스타그/PRICE TAG-transparent/3f, 914mm(100ea/cs)									
															
주문단위	EACH	입수량	1	주문단위	PACK	입수량	100	주문단위	CASE	입수량	100	주문단위	CASE	입수량	100
															
GSK	98275900	GSK	96900051	GSK	95222076	GSK	96340119								
101447/와이어셸브프라이스타그 CLEARVISION METRO STYLE HINGED TICKET MOLDING-1.25Hx3L"(100ea/pk)		TBS106573/POP블랙프라이스타그 /POP SLANTED PRICE TAG FOR PRODUCE-48"Lx1.5"Hx0.5T"(50ea/cs)		아웃오브스탁태그/TEMPORARILY OUT OF STOCK POLYESTER TAG-3.1x 2.63"(200ea/pk)		계산대CLOSED싸인/LANE CLOSED SIGN-10"x6-1/2"									
															
주문단위	PACK	입수량	100	주문단위	CASE	입수량	50	주문단위	PACK	입수량	200	주문단위	EACH	입수량	1
															

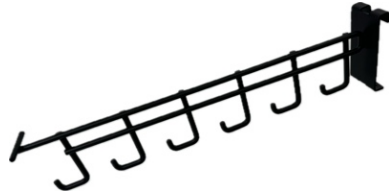

GSK	96900127	GSK	96900128	GSK	96900129	GSK	96900201
CIP/야채이름표태그/CHANNEL TAG INSERT PRODUCE-4 1/2"x1 1/2"(200ea/pk)		B3110052/채널태그프레임/CHANNEL TAG STEEL CLIP-4 1/2"x2 1/2"(25ea/pk)		CTP/채널태그프레임/CHANNEL TAG PLASTIC CLIP-4 1/2"x2 1/2"(25ea/pk)		3색포켓프레임/3 COLOR POCKET FRAMES WITH ADAPTER-(20ea/pk)	
							
주문단위	PACK	입수량	200	주문단위	PACK	입수량	25
							
96900127		96900128		96900129		96900201	

GSK	96900122	GSK	96900123	GSK	96900042	GSK	96900043
CIR/가격태그/CHANNEL TAG INSERT PRICE-(100ea/pk)		B3220057/채널태그클립프레임/CHANNEL TAG LONG CLIP-4 1/2"x2 1/2"/(15ea/pk)		111253/클립곤돌라&냉장선반폴대 접이식레그/CLEARGRIP™ FLEXCHANNEL CLIP-IN TICKET MOLDING W/CLEAR TAPE-- 4ftx1.25"H/folding		109650/클립곤돌라&냉동선반폴대 접이식레그/CLEARGRIP™ FLEXCHANNEL CLIP-IN TICKET MOLDING--30"x1.25"H/folding leg/black(50ea/cs)	
							
주문단위	PACK	입수량	100	주문단위	PACK	입수량	1
							
96900122		96900123		96900037		96900043	

GSK	96900044	GSK	96900045	GSK	96900046	GSK	96900029
107785/클립냉장선반폴대접이식레그/CLEARGRIP™ FLEXCHANNEL CLIP-IN TICKET MOLDING-- 3ftx1.25"H/folding leg/black(50ea/cs)		105414/클립접착식폴대/CLEARGRIP™ FLAT MOUNT TICKET MOLDING W/ CLEAR TAPE--black/4ftx1.25"H(50ea/cs)		107685/클립곤돌라&냉장선반폴대 접이식레그/CLEARGRIP™ FLEXCHANNEL CLIP-IN TICKET MOLDING--4ftx1.25"H/folding leg/black(50ea/cs)		111650/접착식폴대/CLEARVISION FLAT MOUNT TICKET MOLDING W/CLEAR TAPE-- black/3ftx1.25"H(50ea/cs)	
							
주문단위	CASE	입수량	50	주문단위	CASE	입수량	50
							
96900044		96900045		96900046		96900029	

GSK	96900031			GSK	98100132			GSK	98100133			GSK	96340343		
100741/접착식폴대/CLEARVISION FLAT MOUNT TICKET MOLDING W/CLEAR TAPE- black/4ftx1.25"H(100ea/cs)				슬랫월훅/SLAT WALL HOOK- 8"/dia 6mm/chrome(주문단위 100ea)				슬랫월훅/SLAT WALL HOOK- 10"/dia 6mm/chrome(주문단위 100ea)				ISK그리드월8인치더블훅/ ISK GRIDWALL DOUBLE HOOK- 8"(100ea/cs)			
															
주문단위	CASE	입수량	100	주문단위	EACH	입수량	100	주문단위	EACH	입수량	100	주문단위	CASE	입수량	100
															
96900031				98100132				98100133				96340343			

GSK	98215903			GSK	98215905			GSK	98215906			GSK	98215920		
KL-SWSH-6/슬랫월스캐너훅 /SLATWALL SCANNER HOOK- 150mm/6"/dia6mm(100ea/cs)				KL-GWSH-4/그리드월스캐너훅 /GRIDWALL SCANNER HOOK- 100mm/4"/dia6mm(100ea/cs)				KL-GWSH-10/그리드월스캐너훅 /GRIDWALL SCANNER HOOK- 250mm/10"/dia6mm(100ea/cs)				KL-GWMLTH-14/그리드월멀티훅 /GRIDWALL MULTI-HOOK- 14"/dia6mm(10ea/cs)			
															
주문단위	CASE	입수량	100	주문단위	CASE	입수량	100	주문단위	CASE	입수량	100	주문단위	CASE	입수량	10
															
98215903				98215905				98215906				98215920			

GSK	98200194		
S-19990C/슬랫월스캐너훅 /SLATWALL SCANNER HOOKS- chrome/6"(25ea/cs)			
			
주문단위	CASE	입수량	25
			
98200194			

POP

- 청과과일 샐러드 POP



GSK	90300001	GSK	90300002	GSK	90300003	GSK	90300004
청과과일샐러드POP(베리믹스))/BERRY MIX-5.9x1.2"		청과과일샐러드POP(칸탈루프))/CANTALOUPE-5.9x1.2"		청과과일샐러드POP(레드드래곤후 르츠)/DRAGON FRUIT RED- 5.9x1.2"		청과과일샐러드POP(화이트드래곤 후르츠)/DRAGON FRUIT WHITE- 5.9x1.2"	
							
주문단위	EACH	입수량	1	주문단위	EACH	입수량	1
							
90300001		90300002		90300003		90300004	
GSK	90300005	GSK	90300006	GSK	90300007	GSK	90300008
청과과일샐러드POP(옐로우드래곤 후르츠)/DRAGON FRUIT YELLOW- 5.9x1.2"		청과과일샐러드POP(후레쉬두리안))/FRESH DURIAN-5.9x1.2"		청과과일샐러드POP(후르츠믹스))/FRUIT MIX-5.9x1.2"		청과과일샐러드POP(그린파파야샐 러드)/GREEN PAPAYA SALAD- 5.9x1.2"	
							
주문단위	EACH	입수량	1	주문단위	EACH	입수량	1
							
90300005		90300006		90300007		90300008	
GSK	90300009	GSK	90300010	GSK	90300011	GSK	90300012
청과과일샐러드POP(허니글로우파 인애플)/HONEYGLOW PINEAPPLE- 5.9x1.2"		청과과일샐러드POP(허니듀))/HONEYDEW-5.9x1.2"		청과과일샐러드POP(잭후르츠))/JACK FRUIT-5.9x1.2"		청과과일샐러드POP(망고))/MANGO-5.9x1.2"	
							
주문단위	EACH	입수량	1	주문단위	EACH	입수량	1
							
90300009		90300010		90300011		90300012	

GSK	90300013	GSK	90300014	GSK	90300015	GSK	90300016
청과과일샐러드POP(파파야))/PAPAYA-5.9x1.2"		청과과일샐러드POP(파인애플))/PINEAPPLE-5.9x1.2"		청과과일샐러드POP(파인애플믹스))/PINEAPPLE MIX-5.9x1.2"		청과과일샐러드POP(핑크파인애플))/PINK PINEAPPLE-5.9x1.2"	
							
주문단위	EACH	입수량	1	주문단위	EACH	입수량	1
							
90300013		90300014		90300015		90300016	

GSK	90300017	GSK	90300018	GSK	90300019		
청과과일샐러드POP(딸기))/STRAWBERRY-5.9x1.2"		청과과일샐러드POP(수박))/WATERMELON-5.9x1.2"		청과과일샐러드POP(옐로우망고))/YELLOW MANGO-5.9x1.2"			
							
주문단위	EACH	입수량	1	주문단위	EACH	입수량	1
							
90300017		90300018		90300019			

TAPE



IMPERIAL	85183037	IMPERIAL	85183038	GSK	99583000	GSK	91083001								
3/8PVC/백테이프(야채부)/PVC BAG TAPE- 3/8"X180yds/red		3/8PVC/백테이프(야채부)/PVC BAG TAPE- 3/8"X180yds/green		45M-H2/우림클리어박스테이프 /CLEAR POLY BOX TAPE- 48mmx45m/65MC(50ea/cs)		BG002-US/이지라이프고초강력양면테이프/EZLIFE GO DOUBLE SIDED TAPE HEAVY DUTY- 4.72x4.72x0.91/9.85FT/clear									
															
주문단위	EACH	입수량	1	주문단위	EACH	입수량	1	주문단위	CASE	입수량	50	주문단위	EACH	입수량	1
															
85183037		85183038		99583000		91083001									
GSK	95124919	IMPERIAL	85183025	GSK	97002820	GSK	97002821								
H-958/테이프디스펜서/BENCH TAPE DISPENSER- 2"		S-5/백테이프기/BAG TAPER DISPENSER-w(3/8PVC/ 3/8PVC)		H-464/테이프디스펜서/ULINE ULINE HEAVY DUTY TAPE DISPENSERS-2"		H-324/테이프디스펜서/ULINE COMFORT GRIP TAPE DISPENSER- 2"									
															
주문단위	EACH	입수량	1	주문단위	EACH	입수량	1	주문단위	EACH	입수량	1	주문단위	EACH	입수량	1
															
95124919		85183025		97002820		97002821									
GSK	97001169														
H-1714/티켓디스펜서/TAKE A NUMBER TICKET DISPENSER															
															
주문단위	EACH	입수량	1												
															
97001169															

DECORATION & PAD



GSK	95160399	GSK	96360001	GSK	94462004	IMPERIAL	85591001
스시용바란마운틴형/BARAN SUSHI DECORATION(1000ea./pk)		TK-615-02/스시용바란새우형/VINYL DECORATION LEAF EBI BARAN 2GO MODELLINO(1000ea./pk)		900751/스시용바란죽순형/BAMBOO SHOOT DECORATIVE PLASTIC PARTITION BARAN-green(1000ea./pk)		DLAC50/흡수패드/ABSORBANT PAD-4.75x7"(2600ea./cs)	
주문단위	PACK	입수량	1000	주문단위	CASE	입수량	1000
95160399		96360001		94462004		85591001	

GSK	95190104	GSK	90116001	GSK	95460001	GSK	91098046
팬캡/PAN CAP FRUIT PROTECTOR/IVORY(1200ea./cs)		후지사과박스/FUJI APPLE BOX(77ea./cs)		S-12434/목재완충재/UNDYED ASPEN FINE EXCELSIOR-25lb/wood		BOBZCJCTPK/진열용과일모형세트/TOOPYFY ARTIFICIAL FRUITS PACK(20ea./cs)	
주문단위	CASE	입수량	1200	주문단위	CASE	입수량	77
95190104		90116001		95460001		91098046	

GSK	91098047	GSK	91098048	GSK	91098049		
B008Z5TC4C/진열용야채모형세트/REALISTIC ARTIFICIAL VEGETABLES PACK(24ea./cs)		B07JK99MB1/진열용아이비식물모형세트/ARTIFICIAL IVY GARLAND WITH CLIP GREEN FLOWER PLANTS PACK(12ea./cs)		B08ZCFB678/진열용풀모형세트/ARTIFICIAL GRASS PLASTIC PLANTS PACK(12ea./cs)			
주문단위	CASE	입수량	24	주문단위	CASE	입수량	12
91098047		91098048		91098049			

MAT & BASKET



















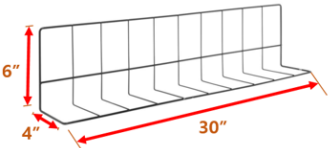
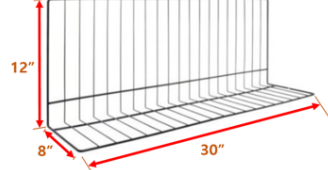
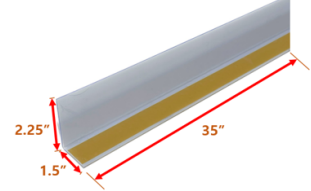



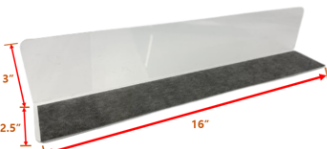
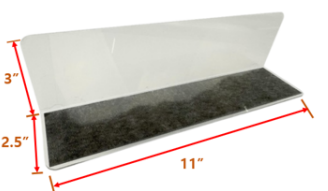
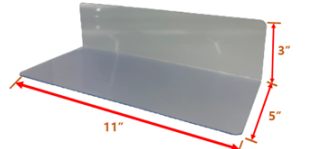





IMPERIAL	85340001			IMPERIAL	85340002			IMPERIAL	85340003			GSK	95179613		
36RRUBBER/진열대고무매트 /RUBBER LINER SUPERGRIP- 36"X60"/red				36GRUBBER/진열대고무매트 /RUBBER LINER SUPERGRIP- 36"X60"/green				36RUBBER/진열대고무매트 /RUBBER LINER SUPERGRIP- 36"X60"/black				3/608S/청과부바스켓/PRODUCE BASKET- 15L"x16"Dx1.5"to4"H/black			
															
주문단위	ROLL	입수량	1	주문단위	ROLL	입수량	1	주문단위	ROLL	입수량	1	주문단위	EACH	입수량	1
 85340001				 85340002				 85340003				 95179613			
GSK	95179615			GSK	91079002			GSK	95340123			GSK	95340124		
SW-PB/청과부바스켓/PRODUCE BASKET- 16"Lx16"Dx1.5"to5"H/black(20ea/c s)				B09NRP8FX8/바스켓 /HANDWOVEN OVAL PLASTIC BASKET-6x 9x 2.6"/wood(20ea/cs)				플라스틱대나무매트(냉장매대용)/PLASTIC BAMBOO MAT- small/400x1000mm/15.75x39.37"				플라스틱대나무매트(냉장매대용)/PLASTIC BAMBOO MAT- large/700x1000mm/27.56x39.37"			
															
주문단위	CASE	입수량	20	주문단위	CASE	입수량	20	주문단위	EACH	입수량	1	주문단위	EACH	입수량	1
 95179615				 91079002				 95340123				 95340124			
GSK	95402033			GSK	98101231			GSK	97001374			GSK	97000937		
GRP36202-BK/일회용검정미끄럼 방지매트/BLACK TRIP FLOOR PIG MAT-36X 5"(10ea/pk)				844B755100/검정고무바닥깔판 /Notrax 755-100 T30 Competitor Black Anti-Fatigue Rubber Floor Mat with Bevel Edge -3' x 5' X 1/2" Thick				8441485R3RD/레드카펫 /CACTUS MAT 1485R-R3-3' X 60' -RED				계산대메모리폼매트/CHECKOUT COUNTER ANTI FATIGUE STANDING MAT W/H-MART DEBOSSSED LOGO-32x20"/0.75"thick/solid black			
															
주문단위	PACK	입수량	10	주문단위	EACH	입수량	1	주문단위	EACH	입수량	1	주문단위	EACH	입수량	1
 95402033				 98101231				 97001374				 97000937			



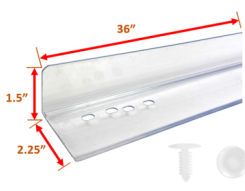

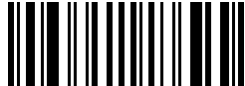

GSK	97999699	GSK	97005088	GSK	97005087	GSK	97005084
H-113R/스탠다드카펫 /STANDARD CARPET MAT- 3'x5'/red		H-485R/스탠다드카펫 /STANDARD CARPET MAT- 3'x8'/red		H-485BL/스탠다드카펫 /STANDARD CARPET MAT- 3'x8'/black		H-485GR/스탠다드카펫 /STANDARD CARPET MAT- 3'x8'/charcoal	
							
주문단위	EACH	입수량	1	주문단위	EACH	입수량	1
							
97999699		97005088		97005087		97005084	
GSK	97999701	GSK	98000304	GSK	97040004	GSK	96336233
H-486R/스탠다드카펫 /STANDARD CARPET MAT- 3'x10'/red		H-486BL/스탠다드카펫 /STANDARD CARPET MAT- 3'x10'/black		H-486GR/스탠다드카펫 /STANDARD CARPET MAT- 3'x10'/charcoal		H-486BLU/스탠다드카펫 /STANDARD CARPET MAT- 3'x10'-blue	
							
주문단위	EACH	입수량	1	주문단위	EACH	입수량	1
							
97999701		98000304		97040004		96336233	
GSK	98108077	GSK	98112063	GSK	98112064		
B1918439/벌크무버카트바스켓포 함 /PRAIRIE VIEW BULK MOVER- LUGCT1BK4-NBT-32-3/4"L x 21-1/4"W x 36"H		B1918437/벌크무벌카트/PRAIRIE VIEW BULK MOVER CART- 4 BUSHEL 30 1/4 X 20 1/2 X 30 1/2" H		B1918438/벌크무벌카트텡 /PRAIRIE VIEW BULKC TUB LUGNBT4- 32 3/4 X 20 1/4 X 15/ 3/4" H			
							
주문단위	EACH	입수량	1	주문단위	EACH	입수량	1
							
98108077		98112063		98112064			

DIVIDING SUPPLIES

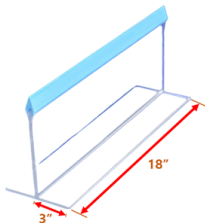
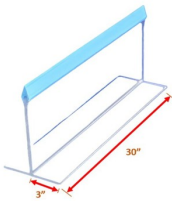
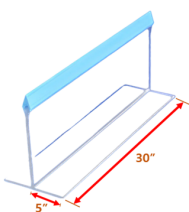

GSK	95179652	GSK	95179653	GSK	95179654	GSK	95179655
CSDIV1482/정육부SAVORY디바이더/SAVORY ALWAYS DELICIOUS DIVIDER—small/14"x4—13/16"		정육부SAVORY디바이더/SAVORY ALWAYS DELICIOUS DIVIDER—large/26"x8"		정육부SAVORY디바이더베이스/BASE FOR SAVORY ALWAYS DELICIOUS DIVIDER—small/14"		정육부SAVORY디바이더베이스/BASE FOR SAVORY ALWAYS DELICIOUS DIVIDER—large/26"	
							
주문단위	EACH	입수량	1	주문단위	EACH	입수량	1
							
95179652		95179653		95179654		95179655	
GSK	96340156	GSK	96340155	GSK	96340165	GSK	96340201
SW-WFD-30128W/와이어L펜스디바이더/L TYPE WIRE FENCE DIVIDER—30"x12"x8"/white(30ea/cs)		SW-LWFD-3064B/와이어L펜스디바이더/L TYPE WIRE FENCE DIVIDER—30"x6"x4"/black(30ea/cs)		SW-WFD-30128B/와이어L펜스디바이더/L TYPE WIRE FENCE DIVIDER—30"x12"x8"/black(30ea/cs)		SW-3F-TFD/테이프프론트스탑디바이더/STOP FRONT DIVIDER W/TAPE—35"x2.25"x1.5"/90 Degree(50ea/cs)	
							
주문단위	CASE	입수량	30	주문단위	CASE	입수량	30
							
96340156		96340155		96340165		96340201	
GSK	96340102	GSK	96340401	GSK	96340400	GSK	96340600
플라스틱자 자석디바이더/PLASTIC SHELF DIVIDER W/MAGNETIC RADIOUS CORNER16"x3"x2.5"x1/16"T/clear(25ea/pk)		플라스틱자 자석디바이더/PLASTIC SHELF DIVIDER W/MAGNETIC RADIOUS CORNER11"x3"x2.5"x1/16"T/clear(25ea/pk)		SW-PD-1153/짧은플라스틱디바이더/PLASTIC DIMDER—280/125/75—1.5T/11"x5"x3"x1/16"T(100pcs/cs)		SW-4F-FD/곤돌라용아크릴프론트디바이더/ACRYLIC FRONT DIVIDER for GONDOLA—46.5"x2.5"x0.25"/clear(30ea/cs)	
							
주문단위	PACK	입수량	25	주문단위	PACK	입수량	25
							
96340102		96340401		96340400		96340600	

GSK	96340700	GSK	96340207	GSK	96340206	GSK	96340113
SW-3F-FD/곤돌라용아크릴프론트디바이더/ACRYLIC FRONT DIVIDER for GONDOLA-34.5"x2.5"x0.25"/clear(40ea/cs)		SW-PUD-48/푸쉬인프론트스탑디바이더/PUSH-IN STOP DIVIDER-48"x1.5"x2.25"/clear(20ea/cs)		SW-PUD-36/푸쉬인프론트스탑디바이더/PUSH-IN STOP DIVIDER-36"x1.5"x2.25"/clear(20ea/cs)		159850/진열대칸막이/CLEAR CASE DIVIDER WITH RED TIP-3"x30"	
							
주문단위	CASE	입수량	40	주문단위	CASE	입수량	20
							
96340700		96340207		96340206		96340113	

GSK	96340127	GSK	96340128	GSK	96340129	GSK	96340125
0632-0360-16-07/수산부블루팁디바이더/CLEAR T TYPE DIVIDER WITH BLUE TIP-small/3x18"		0632-0300-16-07/수산부블루팁디바이더/CLEAR T TYPE DIVIDER WITH BLUE TIP-medium/3x30"(72ea/cs)		0592-0300-16-07/수산부블루팁디바이더/CLEAR T TYPE DIVIDER WITH BLUE TIP-large/5x30"		ETD/계산대막대기/H MART LOGO ETD CASHIER DIVIDER-16"/red	
							
주문단위	EACH	입수량	1	주문단위	EACH	입수량	1
							
96340127		96340128		96340129		96340125	

GSK	96340702
스마트카드광고계산대디바이더/HMART SMART CARD AD CHECKOUT COUNTER DIVIDER-15.8X3.8"(50ea/cs)	
	
주문단위	CASE
입수량	50
	
96340702	

FISH TOOLS



GSK	96313004	GSK	96313010	GSK	96313011	GSK	96313012
11212H/생선용스플리터/FISH SPLITTER-12"		RK-S121 PCP/굴손질용칼/OYSTER KNIFE-3 3/4"/white		RK-S17/조개칼/CLAM KNIFE-3"/white		RK-2022/생선칼/FISH KNIFE-4"/wood	
							
주문단위	EACH	입수량	1	주문단위	EACH	입수량	1
							
96313004		96313010		96313011		96313012	
GSK	96313024	GSK	96363102	GSK	96363301	GSK	96363302
02503/염도측정기/HYDROMETER- 15"x6"xx8"		85092/와이어브러시/WIRE BRUSH/PLAT cs WIRE BLOCK TR-5x10x1-1/4"		플라스틱망치/PLASTIC HAMMER MALLET		69825/플라스틱삽/ PLASTIC SHOVEL WHITE-14"..	
							
주문단위	EACH	입수량	1	주문단위	EACH	입수량	1
							
96313024		96363102		96363301		96363302	
GSK	96363304	GSK	96363400	GSK	96363401	GSK	96363402
9661000/2498-KE/수산부가위/FISHSCISSORS-10"		723/사각그물생선망/ALUMAGUARD BAIT NETS-hoop:15x10"/handle:24"/net depth:4"		724/사각그물생선망/ALUMAGUARD BAIT NETS-hoop:15x15"/handle:24"/net depth:4"		933/원형생선망/ PEAR-D STYLE HOOP-hoop:15x17"/handle:30"/net depth:24"	
							
주문단위	EACH	입수량	1	주문단위	EACH	입수량	1
							
96363304		96363400		96363401		96363402	









GSK	97001289			GSK	97001391			GSK	91062004			GSK	91062005		
93696/알루미늄트레이 /RECTANGULAR RIBBED ALUMINUM MEAT AND SEAFOOD PAN WITH HANDLES -27" x 8 1/2" x 3/4" H				85018수산부트레이/SEAFOOD DISPLAY PAN-30 X 10 X 3/4"H -NSF				C630-2/수산부긴알루미늄팬트레 이/RECTANGULAR FLAT MEAT&SEAFOOD PAN TRAY- 6.5Wx2Hx30L"/aluminum				4070229/수산부스텐레스작은팬트 레이/CHOICE HALF SIZE ANTI JAM TABLE PAN TRAY- 10.5Wx2.5Hx12.75L"/stainless			
															
주문단위	EACH	입수량	1	주문단위	EACH	입수량	1	주문단위	EACH	입수량	1	주문단위	EACH	입수량	1
 97001289				 97001391				 91062004				 91062005			

KNIVES



GSK	96313002	GSK	96313001	GSK	96313007	GSK	96313008
S136PCP/넓은 필렛 나이프/WIDE BONING KNIFE-6"		S138PCP/넓은 필렛 나이프/ WIDE FILLET KNIFE-8"		S133-8PCP/필렛 나이프/FILLET KIFE-8"		S133-9PCP/필렛 나이프/ FILLET KIFE-9"	
							
주문단위	EACH	입수량	1	주문단위	EACH	입수량	1
							
96313002		96313001		96313007		96313008	
IMPERIAL	85398101	GSK	96313003	GSK	96313005	GSK	96313006
CRFCUT/박스칼/BOX CUTTER-3"X1"(12ea./cs)		S11212/도살용칼/ BUTCHER KNIFE-12"		S160-16/피자칼/PIZZA KNIFE-16"		WKC401/중국식칼/CHINESE CLEAVER-8-1/2"	
							
주문단위	CASE	입수량	12	주문단위	EACH	입수량	1
							
85398101		96313003		96313005		96313006	
GSK	96313009	IMPERIAL	85398102	GSK	95422049	GSK	96363101
S5289/중국식칼/STAINLESS HEAVY DUTY CLEAVER-9"		CRFBLD/박스칼용칼날/BLADE FOR BOX CUTTER(100ea./cs)		KR-12SS/벽면칼집/KNIFE RACK 12 SLOT STAINLESS STEEL		SS-1211/숫돌/COMNIATION SHARPENING STONE	
							
주문단위	EACH	입수량	1	주문단위	EACH	입수량	1
							
96313009		85398102		95422049		96363101	

GSK	96363114			GSK	96363201			GSK	96363202			GSK	96363303		
3303-14/야스리/SHARPENING STEEL ROUND SHARPENER-14"				FSP-9/스테인리스스케일러/STAINLESS SCALER				125-12520/라운드스케일러/SS-15 ROUND SCALER(30ea/cs)				KK16/핀보너/PIN BONER STAINLESS STEEL			
															
주문단위	EACH	입수량	1	주문단위	EACH	입수량	1	주문단위	CASE	입수량	30	주문단위	EACH	입수량	1
															
96363114				96363201				96363202				96363303			

GSK	96600015			IMPERIAL	86420101			GSK	95562165			GSK	96600009		
DOUGH/스크래퍼/해라/DOUGH SCRAPER				MEATSCRAPE/고기스크래퍼/MEAT SCRAPER				갈비뼈 발골기/ RIB DISPOSAL STAINLESS/ 106X195X3mm				HUD-142-4T/정육기계칼날/BAND SAW BLADES- 4T-142"(6ea/cs)			
															
주문단위	EACH	입수량	1	주문단위	EACH	입수량	1	주문단위	EACH	입수량	1	주문단위	CASE	입수량	6
															
96600015				86420101				95562165				96600009			

GSK	96600008			GSK	96600069			GSK	96600070		
정육기계칼날/BAND SAW BLADES PITCH 3/L-108" W-5/8"(6ea/cs)				정육기계칼날/BAND SAW BLADES PITCH 4-126"(6ea/cs)				정육기계칼날/BAND SAW BLADES 3T-142"(6ea/cs)			
											
주문단위	CASE	입수량	6	주문단위	CASE	입수량	6	주문단위	CASE	입수량	6
											
96600008				96600069				96600070			

STRINGS & RUBBER BAND



IMPERIAL	85184016			IMPERIAL	85184031			IMPERIAL	85184032			IMPERIAL	85184033		
16RB / #16고무줄 / ALLIANCE ADVANTAGE RUBBER BAND— #16 / red / 454g(600ea / pk)				31RB / #31고무줄 / ALLIANCE ADVANTAGE RUBBER BAND— #31 / beige / 454g(700ea / pk)				32RB / #32고무줄 / ALLIANCE ADVANTAGE RUBBER BAND— #32 / beige / 454g(700ea / pk)				33RB / #33고무줄 / ALLIANCE ADVANTAGE RUBBER BAND— #33 / beige / 454g(700ea / pk)			
															
주문단위	PACK	입수량	600	주문단위	PACK	입수량	700	주문단위	PACK	입수량	700	주문단위	PACK	입수량	700
															
85184016				85184031				85184032				85184033			

IMPERIAL	85184062			IMPERIAL	85182850			IMPERIAL	85182851			IMPERIAL	85182852		
62RB / #62고무줄 / ALLIANCE ADVANTAGE RUBBER BAND— #62 / red / 454g(600ea / pk)				850NYTW / 박스포장끈 / 1PLY POLY TWINE—10lb / white				16COT / 고기부실끈 / 16 PLY COTTON TWINE—2lb				12COT / 정육부실끈 / COTTON TWINE—2lb / 12PLY			
															
주문단위	PACK	입수량	600	주문단위	EACH	입수량	1	주문단위	EACH	입수량	1	주문단위	EACH	입수량	1
															
85184062				85182850				85182851				85182852			

IMPERIAL	85191902			GSK	95191016		
1514GA / 종이박스철사 / BAILING WIRE FOR CARDBOARD—15' 14gage(250ea / cs)				TT—HMART16 / 야채부적색철사끈 / TWIST TIES—16x3 / 8" / RED HMART LOGO(300ea / pk)(10pk / cs)			
							
주문단위	CASE	입수량	250	주문단위	CASE	입수량	300
							
85191902				95191016			

























SCISSORS













GSK		96312001		GSK		96363304	
SCISSORG/쪽가위포도가위 /GRAPE SCISSORS				9661000/2498-KE/수산부가위 /FISHSCISSORS-10"			
							
주문단위	EACH	입수량	1	주문단위	EACH	입수량	1
 96312001				 96363304			

UTENSIL



GSK		95598015		IMPERIAL		85422001		IMPERIAL		85422008		IMPERIAL		85422020	
고토프리미엄일회용나무젓가락 /KOTO PREMIUM DISPOSABLE WOODEN CHOPSTICKS*72071114*(100pairs/4 0ea/cs)				P2SSH/숟가락/SPOON HVY DUTY(1000ea/cs)				P4TASTE/데모용숟가락/TASTING SPOON-white(3000ea/cs)				P2FH/포크헤비/FORK HEAVY(1000ea/cs)			
															
주문단위	CASE	입수량	40	주문단위	CASE	입수량	1000	주문단위	CASE	입수량	3000	주문단위	CASE	입수량	1000
 95598015				 85422001				 85422008				 85422020			
IMPERIAL		85422004		IMPERIAL		85422027		IMPERIAL		85422022		GSK		98100744	
IPWS/비닐포장된숟가락 /WAPPED SPOON MEDIUM WEIGHT-IPWS(1000ea/cs)				IPWF/비닐포장된포크/WAPPED FORK MED WT-(1000/cs)				F&B/IPWK/포장된플라스틱ナイ프 /CAREFREE POLYPRO WHITE MEDIUM WRAPPED KNIFE- white(1000ea/cs)				4070013/구멍난스팀테이블팬 /CHOICE FULL SIZE 1 1/4" DEEP PERFORATED SS STEAM TABLE- 12.75Wx1.25Hx20.75L"			
															
주문단위	CASE	입수량	1000	주문단위	CASE	입수량	1000	주문단위	CASE	입수량	1000	주문단위	EACH	입수량	1
 85422004				 85422027				 85422022				 98100744			
GSK		98100745		GSK		98100743		GSK		98200116		GSK		98117108	
4070023/구멍난스팀테이블팬 /CHOICE FULL SIZE 2 1/2" DEEP PERFORATED SS STEAM TABLE- 12.75Wx2.5Hx20.75L"				4070043/구멍난스팀테이블팬 /CHOICE FULL SIZE 4" DEEP PERFORATED SS STEAM TABLE- 12.75Wx4Hx20.75L"				4070063/구멍난스팀테이블팬 /CHOICE FULL SIZE 6" DEEP PERFORATED SS STEAM TABLE- 12.75Wx6Hx20.75L"				4070069/스테인레스초이스폴사이 즈팬/CHOICE FULL SIZE 6" DEEP SS STEAM TABLE PAN- 12.75Wx6Hx20.75L"			
															
주문단위	EACH	입수량	1	주문단위	EACH	입수량	1	주문단위	EACH	입수량	1	주문단위	EACH	입수량	1
 98100745				 98100743				 98200116				 98117108			





GSK	98100739			GSK	96304212			GSK	96420108			GSK	98010307		
4070110 / 초이스폴사이즈스테인레스스틸스팀팬커버 / CHOICE FULL SIZE S.S STEAM TABLE COVER - FULL SIZE				407PC1HDC / 힌지양념육뚜껑 / FULL SIZE POLYCARBONATE HINGED PASTRY COVER - FITS ANY FULL SIZE STEAM TABLE PAN				407POA8 / 페일오프너 / PAIL OPENER - 8 1/2"				SW-STSB / 스테인레스대야 / STAINLESS STEEL BASIN - 78cmx22cm / 2500g			
															
주문단위	EACH	입수량	1	주문단위	EACH	입수량	1	주문단위	EACH	입수량	1	주문단위	EACH	입수량	1
															
98100739				96304212				96420108				98010307			

GSK	91022006		
B0CT54S3GD / 시식용플라스틱포크 / DISPOSABLE PLASTIC FRUIT FORKS - 3.5 x 0.28" / clear (500ea / cs)			
			
주문단위	CASE	입수량	500
			
91022006			

RESTAURANT SUPPLY

<WEST ONLY>











ACTION	91000060			ACTION	91000110			ACTION	91000157			ACTION	98117055		
KMI-HD2146/라이스볼/HD2146 RICE BOWL 4-5/8"/10oz/WHITE				CARL-N1800/둥근컨테이너 /180002 BAINS MARIE- 18qt/12.25"X13"/WHITE				PAN-SS-P-FS2/플사이즈구멍난 팬/607002P PAN PERF FULL/12.75"X20.75"X2.5"/ALUMIN UM				PAN-SS-1/3-6/스테인리스스틸 스토리지컨테이너(바트)/CARLISLE SS STORAGE CONTAINER- 12.75"X6.88"X6"/6qt			
															
주문단위	EACH	입수량	1	주문단위	EACH	입수량	1	주문단위	EACH	입수량	1	주문단위	EACH	입수량	1
															
91000060				91000110				91000157				98117055			
ACTION	91000112			ACTION	98000780			ACTION	91000111			ACTION	91000804		
MUND-4654-22/간지개포크 /4654-22 BROILER FORK-22"				KMI-7021/네모난접시 /RECTANGLE PLATE 15" X 11"				INSETPAN-11/스테인레스통/INS- 11.0M INSET, 24 GAUGE STAINLESS STEEL-11qt/10.5"X9"/ALUMINUM				HALC-1618/감자매셔/POTATO MASHER 4"*4"			
															
주문단위	EACH	입수량	1	주문단위	EACH	입수량	1	주문단위	EACH	입수량	1	주문단위	EACH	입수량	1
															
91000112				98000780				91000111				91000804			
ACTION	91000061			ACTION	91000096			ACTION	91098026			ACTION	91000086		
OVENMITT-GR-17/오븐장갑 /TFR-17 OVEN MITT-17"/GREEN				POTLID-AL-10/팬커버/EWC10 COVER-10"/SILVER				PAN-SS-1/2-4/스테인레스스틸 팬/STAINLESS STEEL PAN- 4" deep/7qt				MIXINGPOT-AL-25/믹싱팟 /MIXINGPOT-AL-25 SOUP/MIXING POT-25"x10"/ALUMINUM			
															
주문단위	EACH	입수량	1	주문단위	EACH	입수량	1	주문단위	EACH	입수량	1	주문단위	EACH	입수량	1
															
91000061				91000096				91098026				91000086			

ACTION	91000104			ACTION	91000062			ACTION	91000066			ACTION	91000100		
KMI-WT5092W/둥근접시 /WT5092W BOWL 10-1/4" DIA 6/24-52oz/WHITE				KMI-US5713/3구소스볼/US5713 SAUCER 3 COMPARTMENT IVORY 12/120-WHITE				KMI-US5232/둥근접시/US5232 IVORY SQUARE PLATE IVORY 12/192-4"x0.5"/IVORY				KMI-LJP1118W/둥근접시 /LJP1118W PLATE SQUARE- 11.5"x11.5"/WHITE			
															
주문단위	EACH	입수량	1	주문단위	EACH	입수량	1	주문단위	EACH	입수량	1	주문단위	EACH	입수량	1
															
91000104				91000062				91000066				91000100			
ACTION	91000101			ACTION	91000068			ACTION	91000069			ACTION	98000748		
KMI-708/사각접시/708 RECTANGLE PLATE 10" 6/48- 10"/WHITE				INSETPAN-07/스테인레스통/INS- 7.0M INSET, 7 QUART 24 GAUGE STAINLESS STEEL- 7qt/8.5"x8"/SILVER				INSETPAN-04/스튜팟/INSET PAN 4 QT S/S-4qt/6.5"/SILVER				HK-LD-S/11CM국자/LD-S Ladle 11cm S/S (S)			
															
주문단위	EACH	입수량	1	주문단위	EACH	입수량	1	주문단위	EACH	입수량	1	주문단위	EACH	입수량	1
															
91000101				91000068				91000069				98000748			
ACTION	91000284			ACTION	91000085			ACTION	91000063			ACTION	91000102		
GR-152005/그린도마/WINCO Green Cutting Board/15"x20"x1/2"				FRYPAN-TF-12/프라이팬 /SEW1030 FRY PAN 12" (SILVERSTONE) (EAGLEWARE)-12"				FONW-1303/팬그리퍼/PAN GRIPPER W/RED HANDLE-RED				CAMB-1418CT110/사각서빙트레 이/1418CT110 CAMTREAD SERVING TRAY FIBERGLASS WITH NON-SKID SURFACE/RECTANGULAR/14"x18"			
															
주문단위	EACH	입수량	1	주문단위	EACH	입수량	1	주문단위	EACH	입수량	1	주문단위	EACH	입수량	1
															
91000284				91000085				91000063				91000102			

ACTION	91000074			ACTION	91098024			ACTION	91000098			ACTION	91000088		
TARH-SLNS536/면스트레이너 /SLNS536 NOODLE STRAINER (LARGE)S/S FLAT BOTTOM WOOD HANDLE-6"x5.38"x6"/SILVER				PAN-SS-1/2-2/푸드팬/608122 PAN 1/2 SIZE X 2-1/2" S/S- 12.75"x10.38"x2.5"/SILVER				ESCA-SCDGM33/디지털저울 /SCDGM33 33 LBS M-SERIES DIGITAL PORTION CONTROL SCALE-12"x10.25"x4.15"/SILVER				BOARD-WH-182475/커팅보드 /CBH-1824 CUTTING BOARD 2PSS054-18"x24"/WHITE			
															
주문단위	EACH	입수량	1	주문단위	EACH	입수량	1	주문단위	EACH	입수량	1	주문단위	EACH	입수량	1
															
91000074				91098024				91000098				91000088			

ACTION	91000089			ACTION	91000087			ACTION	91000092			ACTION	91000082		
BOARD-WH-152075/커팅보드 /CBH-1520 CUTTING BOARD ON0037-15"x20"/WHITE				ARAV-00858/커팅보드/858 CUTTING BOARD 15-7/8"x23- 3/4"x7/8", NONSLIP- 15.88"x23.75"/WHITE				ARAV-00102/커팅보드/102 CUTTING BOARD 11-7/8"x15- 7/8"x7/8", NONSLIP- 12"x15.88"/WHITE				SANJ-CBM1622C/보트매트 /CBM1622 BOARD MAT- 16"x22"/WHITE			
															
주문단위	EACH	입수량	1	주문단위	EACH	입수량	1	주문단위	EACH	입수량	1	주문단위	EACH	입수량	1
															
91000089				91000087				91000092				91000082			

ACTION	91000067			ACTION	91000090			ACTION	91000064			ACTION	91000083		
CARL-N2200/컨테이너/220002 BAINS MARE 22 QT-22qt/WHITE				CARL-N1202/둥근컨테이너뚜껑 /120202 COVER 12, 18 & 22 QT ROUND-12.75"/WHITE				VOLL-47139/스쿱/47139 DISHER #6 5-1/30Z/9.88"/WHITE				CARL-60912XRS/프라이팬 /60912XRS FRY PAN 12" EXCALIBUR-12"			
															
주문단위	EACH	입수량	1	주문단위	EACH	입수량	1	주문단위	EACH	입수량	1	주문단위	EACH	입수량	1
															
91000067				91000090				91000064				91000083			

ACTION	91000079			ACTION	91000080			ACTION	91000078			ACTION	91000081		
WINC-SCF-6R/스키머/SCF-6R SKIMMER 6-1/2" ROUND MESH- 5.5"(head)/13"/SILVER				WINC-SC-9R/스키머/SC-9R SKIMMER 9" ROUND- 9"(head)/13"/SILVER				WINC-SC-7R/스키머/SC-7R SKIMMER 7" ROUND WIRE- 7"(head)/13"/SILVER				WINC-SC-12R/스키머/SC-12R SKIMMER ROUND 12" WIRE- 12"(head)/13"/SILVER			
															
주문단위	EACH	입수량	1	주문단위	EACH	입수량	1	주문단위	EACH	입수량	1	주문단위	EACH	입수량	1
															
91000079				91000080				91000078				91000081			

ACTION	91000077			ACTION	91000071			ACTION	91000072			ACTION	91000073		
WINC-MXB-1300Q/믹싱볼 /MXBT-1300Q MIXING BOWL 13 QT S/S-14.625"/SILVER				WINC-INS-2.5/스테인레스통 /INS-2.5 INSET PAN 2.5 QT S/S-25qt/4.75"x6.125"/SILVER				WINC-CCS-12F/면스트레이너 /CCS-12F CHINA CAP STRAINER-12"/SILVER				WINC-BSOT-18/실버스푼 /BSLD-18HD SPOON-18"/SILVER			
															
주문단위	EACH	입수량	1	주문단위	EACH	입수량	1	주문단위	EACH	입수량	1	주문단위	EACH	입수량	1
															
91000077				91000071				91000072				91000073			



ACTION	91000103			ACTION	91000094			ACTION	91000091			ACTION	91000108		
VOLL-90662/스테인레스통 /90662 PAN III S/S 2PU077-1/6 X 6"/SILVER				VOLL-434212/소스팬/434212 SAUCE PAN 2-3/4 QT- 6.5"x4.25"/ALUMINUM				STOCKPOT-ECON40/스튜팟 /AXS-40 STOCK POT 40 QT ONLY POT-14.25"x15"/ALUMINUM				STOCKPOT-AL-160/스튜팟 /ALSOSP014 STOCK POT 160 QT HEAVY-DUTY ALUMINUM- 160qt/ALUMINUM			
															
주문단위	EACH	입수량	1	주문단위	EACH	입수량	1	주문단위	EACH	입수량	1	주문단위	EACH	입수량	1
															
91000103				91000094				91000091				91000108			

ACTION		91000105		ACTION		91000093		ACTION		91000095		ACTION		91000097	
STOCKPOT-AL-140/스튜팟 /ALSKSP013 STOCK POT 140 QT HEAVY-DUTY ALUMINUM- 160qt/ALUMINUM				SAUCEPAN-AL-02/소스팬 /EWA2 SAUCE PAN 2 QT ALUM (EAGLEWARE)-8"x4.5"/ALUMINUM				SAUCEPAN-AL-04/소스팬 /EWA4 SAUCE PAN 4 QT ALUM (EAGLEWARE)-9.5"x5"/ALUMINUM				SAUCEPOT-AL-8.5/소스팬 /EW0812 SAUCE POT 8-1/2 QT ALUM 10" DIA (EAGLEWARE)- 10"x5.6"/ALUMINUM			
															
주문단위	EACH	입수량	1	주문단위	EACH	입수량	1	주문단위	EACH	입수량	1	주문단위	EACH	입수량	1
															
91000104				91000093				91000095				91000097			

ACTION		91000107		ACTION		91000065	
POTLID-AL-22/스튜팟/ALPC- 140 COVER 22" FOR STOCK POT 140/160 QT-22"/SILVER				POTLID-AL-12/팬커버/ALEGACY EWC20 COVER-12"/ALUMINUM			
							
주문단위	EACH	입수량	1	주문단위	EACH	입수량	1
							
91000107				91000065			

OFFICE SUPPLIES

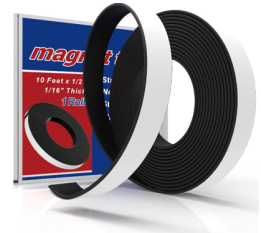

GSK		97001529		GSK		97001530	
MEMX NANO D MEMX NANO DOUBLE SIDED TAPE HEAVEY DUTY-16.4 FT				테이프형자석/MAGNETIC TAPE (10 Feet x 1/16" Thick x 1/2" Wide)			
							
주문단위	EACH	입수량	1	주문단위	EACH	입수량	1
 97001529				 97001530			

ARTBOX & DABADO

- SUPPLY



GSK	98238680	GSK	98238681	GSK	98238682	GSK	98238683
08001571/아트박스매장용플라스틱바구니/ARTBOX SHOPPING BASKET—280x220x160mm/—small/—navy&red handle		08001570/아트박스매장용플라스틱바구니/ARTBOX SHOPPING BASKET—500x350x240mm/—large/—navy&red handle		08000835/아트박스플라스틱바구니거치대/ARTBOX SHOPPING BASKET HOLDER—medium/—chrome		08000839/아트박스플라스틱바구니거치대/ARTBOX SHOPPING BASKET HOLDER—xlarge/—chrome	
							
주문단위	EACH	입수량	1	주문단위	EACH	입수량	1
							
98238680		98238681		98238682		98238683	
GSK	95202011	GSK	96900041	GSK	98234921	GSK	98234920
ARTBOX 페이드스티커/ARTBOX PAID STICKER—51x16mm(1000ea./rl)		POP플라스틱 자석프레임/LETTER PLASTIC FRAME MAGNETIC BASE—1"Wx1— 1/4"Hx3"L(10ea./pk)		B0787Q54M1/NEOSMULK MAGNETIC HOOKS—27lb(10ea./pk)		B082QQBWS8/CHANCAM JOB SHOP TICKET HOLDER VINYL PLASTIC SLEEVE—4.25x6.38"(10ea./pk)	
							
주문단위	ROLL	입수량	1000	주문단위	PACK	입수량	10
							
95202011		96900041		98234921		98234920	
GSK	97001260	GSK	98234924	GSK	98234923	GSK	98234926
B0B6P717PB/프라스틱클리어훅/Self ADHESIVE HANGING TABS HEAVY DUTY CLEAR PLASTIC TAGS HOOK—1 3/4" X 1" (300/PACK)		B06Y3LQ5GN/FOR DABADU 마그네틱사인홀더/MASTER MAGNETICS MAGNETIC SIGN HOLDER—white(6ea./pk)		B0B8VWV1JH/ FOR DABADU 사진 프레임/PICRIT 8X10 PICTURE FRAME SET OF12—white(12ea./cs)		B0118B1TAE/FOR DABADU 수납용 정리함/ACRYLIC TRAY DECORATIVE COUNTERTOP VANITY ORGANIZER—8" x 12" x 2"/clear	
							
주문단위	PACK	입수량	300	주문단위	PACK	입수량	6
주문단위	PACK	입수량	300	주문단위	PACK	입수량	6
주문단위	CASE	입수량	12	주문단위	EACH	입수량	1
							
97001260		98234924		98234923		98234926	

GSK	98234928	GSK	98234931	GSK	91096001	GSK	91096002
B09Q38XC13/FOR DABADU 아크릴 4분할펜꽂이/4 COMPARTMENTS ACRYLIC PEN HOLDER—clear(4pk/set)		B096WZS72K/FOR DABADU 아크릴 라이저/2 SETS ACRYLIC DISPLAY RISERS—3",4",5"/clear		B0BBD1BLWG/아트박스벽걸이선반/ACRYLIC SHELVES FOR WALL DECORATION—15x4x2"/clear(4ea/cs)		YAKELI—10PC/다바도진열아크릴스탠드/BOLOYO ACRYLIC DISPLAY STAND HOLDER—3.94"x5.31"x4.13"/clear(10/cs)	

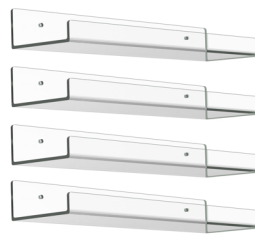
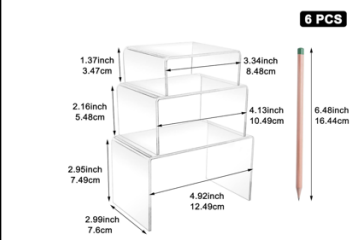
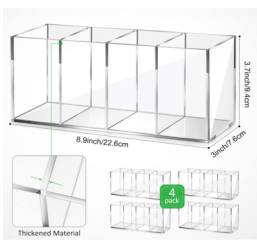

주문단위	PACK	입수량	4	주문단위	EACH	입수량	1	주문단위	CASE	입수량	4	주문단위	CASE	입수량	10
98234928				98234931				91096001				91096002			

GSK	91096003	GSK	91096004	GSK	91096005	GSK	91096006
B0CG9MP145/다바도아크릴3단진열스탠드/HIMEI ACRYLIC DISPLAY RISER, TIERED DISPLAY STAND/—clear(2S,2M,2L—1set/6ea/cs)		GUDE88/다바도자석뚜껑달린플라스틱보관함/GUDEMAY CLEAR STACKABLE PLASTIC STORAGE BINS WITH MAGNETIC LID—8.66"x10.63"x14.17"/clear(3ea/cs)		B0B53WPTD6/다바도헤어밴드2단디스플레이/BIGFETY HEADBAND HOLDER, ACRYLIC HEADBAND ORGANIZER STAND (2—TIER & 2—PANEL)/white(2ea/cs)		8—2XDOWN—OVSZ—W/3구듀얼멀티탭코드컨실러/SOCKET SOLUTIONS DUAL CORD CONCEALER KITS, TWO 3 OUTLET POWER STRIPS, TWO 8—FT CORDS,	



주문단위	CASE	입수량	6	주문단위	CASE	입수량	3	주문단위	CASE	입수량	2	주문단위	EACH	입수량	1
91096003				91096004				91096005				91096006			

GSK	95599007	GSK	95599008	GSK	95599009	GSK	95599010
08001595/아트박스유니폼(반팔)/ARTBOX UNIFORM SHORT SLEEVE SHIRT—medium/mint		08001596/아트박스유니폼(반팔)/ARTBOX UNIFORM SHORT SLEEVE SHIRT—large/mint		08001597/아트박스유니폼(반팔)/ARTBOX UNIFORM SHORT SLEEVE SHIRT—X—Large/mint		08001599/아트박스유니폼(반팔)/ARTBOX UNIFORM SHORT SLEEVE SHIRT—medium/black	

주문단위	EACH	입수량	1	주문단위	EACH	입수량	1	주문단위	EACH	입수량	1	주문단위	EACH	입수량	1
95599007				95599008				95599009				95599010			

GSK	95599011	GSK	95599012	GSK	98238953	GSK	98238954								
08001600/아트박스유니폼(반팔)/ARTBOX UNIFORM SHORT SLEEVE SHIRT—large/black		08001601/아트박스유니폼(반팔)/ARTBOX UNIFORM SHORT SLEEVE SHIRT—X—Large/black		아트박스엑스배너스탠드/ARTBOX X BANNER STAND		아트박스엑스배너키밍순/ARTBOX X BANNER COMING SOON									
															
주문단위	EACH	입수량	1	주문단위	EACH	입수량	1	주문단위	EACH	입수량	1	주문단위	EACH	입수량	1
															
95599011		95599012		98238953		98238954									
GSK	98238955	GSK	98234925	GSK	91096007	GSK	91096008								
아트박스엑스배너그랜드오픈/ARTBOX X BANNER GRAND OPENING		B00RNFROQ/FOR DABADU 2단 회전디스플레이랙/REGISTER DISPLAY STAND 2 TIER SILVER METAL SPINNING RACK—silver		B08RB14JPH/아트박스응원봉거치대/NUOBESTY 6PCS DOLL STAND DISPLAY HOLDER (MOQ/6ea)—3.94x2.17x0.79"/white		B0CN36NTXG/아트박진열아크릴스탠드/CLBUTGE 6-INCH ACRYLIC DISPLAY STAND HOLDER—4x4x5.9"/clear(6/cs)									
															
주문단위	EACH	입수량	1	주문단위	EACH	입수량	1	주문단위	EACH	입수량	1	주문단위	CASE	입수량	6
															
98238955		98234925		91096007		91096008									
GSK	98215914	GSK	98215915	GSK	98215918	GSK	98215919								
아트박스슬랫월훅/ARTBOX SLAT WALL HOOK—50mm/2"/dia5mm/chrome(30ea/cs)		아트박스슬랫월훅/ARTBOX SLAT WALL HOOK—100mm/4"/dia5mm/chrome(30ea/cs)		아트박스패그보드훅/ARTBOX PEGBOARD HOOK—100mm/4"/dia5mm/white(30ea/cs)		아트박스패그보드훅/ARTBOX PEGBOARD HOOK—150mm/6"/dia5mm/white(30ea/cs)									
															
주문단위	CASE	입수량	30	주문단위	CASE	입수량	30	주문단위	CASE	입수량	30	주문단위	CASE	입수량	30
															
98215914		98215915		98215918		98215919									

GSK		98215923		GSK		98215924		GSK		98215925		GSK		98215926	
아트박스크로스바훅 / ARTBOX CROSS BAR HOOK— 50mm / 2" / dia5mm / white (30ea / cs)				아트박스크로스바훅 / ARTBOX CROSS BAR HOOK— 100mm / 4" / dia5mm / white (30ea / cs)				아트박스크로스바훅 / ARTBOX CROSS BAR HOOK— 150mm / 6" / dia5mm / white (30ea / cs)				아트박스크로스바훅 / ARTBOX CROSS BAR HOOK— 200mm / 8" / dia5mm / white (30ea / cs)			
															
주문단위	CASE	입수량	30	주문단위	CASE	입수량	30	주문단위	CASE	입수량	30	주문단위	CASE	입수량	30
															
98215923				98215924				98215925				98215926			

GSK		98215927	
아트박스크로스바훅 / ARTBOX CROSS BAR HOOK— 250mm / 10" / dia5mm / white (30ea / cs)			
			
주문단위	CASE	입수량	30
			
98215927			

EQUIPMENT

- SHOPPING CART & BASKET



GSK	98214502	GSK	98101256	GSK	96336110	GSK	98200421
MC-D80L/쇼핑카트/SHOPPING CART GALVANIZE ZINC & CLEAR POWDER COATING- 80L/750(510x240)FHx830Lx975RHx 520mmW		MC-D130L/쇼핑카트/SHOPPING CART ZINC&GREY POWDER COATING- 130L/825(465x360)FHx890Lx100RH x510mmW		MC-D210L/쇼핑카트/SHOPPING CART BRIGHT ZINC&TRANSPARENT POWDER COATING- 210L/825FHx1070Lx1035RHx590mm W		KNM550/플라스틱쇼핑카트/Peggs Plastic Shopping Cart-130L/HNL	
							
주문단위	EACH	입수량	1	주문단위	EACH	입수량	1
							
98214502		98101256		96336110		98200421	
GSK	96336129	GSK	96336130	GSK	98299001	GSK	98211501
KNM700RD/쇼핑카트/H-Mart LOGO PEGGS SHOPPING CART- 210L/red		KNM700GT/쇼핑카트/H-Mart LOGO PEGGS SHOPPING CART- 210L/granite		40W/쇼핑카트/Bright Zinc plus Clear Poly Anti-rust Wire Shopping Cart with gray bumpers-180L		WBB3131263/PT플라스틱쇼핑카트 /PTTM INC LARGE PLASTIC SHOPPING CART W/H-MART LOGO- 189L/24.75Wx37Lx40.75H" /black	
							
주문단위	EACH	입수량	1	주문단위	EACH	입수량	1
							
96336129		96336130		98299001		98211501	
GSK	98200198	GSK	98234943	GSK	96336131	GSK	98251900
7R141011HMT001/플라스틱쇼핑카트/BEMIS FULL SIZE SHOPPING CART-11,175cu.in./183L		B0BCXM3N92/쇼핑카트로프/C3 ST DEVICE FOR COMPLETE CART CONTROL SHOPPING CART ROPE- 10Dx5Wx28H"		쇼핑카트용아기 의자/SHOPPING CART BABY SEAT (RED) FOR MJY-210C2		쇼핑카트수리용틀세트/SHOPPING CART TOOL SET	
							
주문단위	EACH	입수량	1	주문단위	EACH	입수량	1
							
98200198		98234943		96336131		98251900	

GSK	98100614	GSK	98100613	GSK	98100615	GSK	98100616
MC-D TYPE 쇼핑카트앞바퀴 /SHOPPING TROLLEY FRONT WHEEL-4"(for MC-D80L)		MC-D TYPE 쇼핑카트뒷바퀴 /SHOPPING TROLLEY REAR WHEEL-5"(for MC-D130L)		MC-D TYPE 쇼핑카트앞바퀴 /SHOPPING TROLLEY FRONT WHEEL-5"(for MC-D130L&MC- D210L)		MC-D TYPE 쇼핑카트뒷바퀴 /SHOPPING TROLLEY REAR WHEEL-5"(for MC-D210L)	
							
주문단위	EACH	입수량	1	주문단위	EACH	입수량	1
							
98100614		98100613		98100615		98100616	
GSK	96336133	GSK	96336132	GSK	96336125	GSK	96336126
C301/KNM700 TYPE 앞바퀴 /SHOPPING TROLLEY FRONT SWIVEL POLY CASTER-5"		C001B/KNM700 TYPE 뒷바퀴 /SHOPPING TROLLEY REAR POLY WHEEL-5x1.25"		MJY-210C2쇼핑카트용New앞바퀴 /NEW FRONT WHEEL FOR GREY SHOPPING CART MJY-210C2		MJY-210C2쇼핑카트용New뒷바퀴 /NEW REAR WHEEL FOR GREY SHOPPING CART MJY-210C2	
							
주문단위	EACH	입수량	1	주문단위	EACH	입수량	1
							
96336133		96336132		96336125		96336126	
GSK	96336197	GSK	96336196	GSK	96336202	GSK	98214500
MC-D210L 쇼핑카트핸들홀더 /MC-D210L SHOPPING CART HANDLE PROTECTOR-1pr(left&right side)		MC-D210L 쇼핑카트로고핸들 /MC-D210L SHOPPING CART H- MART LOGO HANDLECART HANDLE		MC-D TYPE 쇼핑카트유아안전벨 트/BABY SEAT BELT FOR SHOPPING TROLLEY(for MC- D80L&130L&210L)		쇼핑카트용아기 의자 /SHOPPING CART TROLLEY BABY SEAT for MC-D80L & MC-D210L	
							
주문단위	PAIR	입수량	2	주문단위	EACH	입수량	1
							
96336197		96336196		96336202		98214500	

GSK	98214501			GSK	96336117			GSK	96336116			GSK	98215500		
쇼핑카트용아기 의자 / SHOPPING CART TROLLEY BABY SEAT for MC-D130L				XJL-12 / 쇼핑바스켓 / H-MART LOGO SHOPPING BASKET - red / 19" W x 13" D x 10.5" H / 480L x 330 W x 265Hmm / 28L (25ea / cs)				쇼핑바스켓홀더 w / 바퀴 / SHOPPING BASKET HOLDER W / WHEELS - 2" - 4wheels w / 2break for XJL-12 / 460L x 325W x 350Hmm				KLL-Z04 / 손잡이 고정롤 쇼핑바스켓 / H-MART LOGO ROLL SHOPPING BASKET - red / 20.47L x 14.96W x 35.43H" / 520L x 380W x 900Hmm / 68L			
															
주문단위	EACH	입수량	1	주문단위	CASE	입수량	25	주문단위	EACH	입수량	1	주문단위	EACH	입수량	1
															
98214501				96336117				96336116				98215500			

GSK	96336201			GSK	96336203			GSK	98100826		
쇼핑바스켓손잡이 / SHOPPING BASKET HANDLE - black				쇼핑카트앞부분모서리보호대 / TROLLEY FRONT PROTECTOR (SAME SIZE FOR 180 & 210L) - (200ea / ctn)				쇼핑카트홀더 / TROLLEY STOPPER, SHOPPING CART HOLDER FOR 210L - TROLLEY BACK DOOR PLASTIC STOPPER			
											
주문단위	EACH	입수량	1	주문단위	PAIR	입수량	2	주문단위	EACH	입수량	1
											
96336201				96336203				98100826			

EQUIPMENT

- GONDOLA & RACK



STORAGE RACK SPECIAL SALE

문의사항이 있으시면 언제든지 연락주세요.
친절히 안내 드리겠습니다.
GSK Equipment Department

Cheontaek Hong
E-mail : cheontaek.hong@hmart.com
Tel : 201-933-0037 (Ext. 2704)

98100142 듀티랙포스트/DUTY RACK POST-118"
98100143 듀티랙빔/DUTY RACK BEAM-76"
98100144 듀티랙셴프/DUTY RACK METAL SHELF-39.60"x21.8"

118"

NO
SMOKING

24"

76"







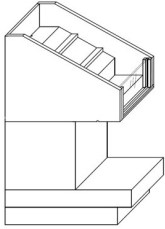
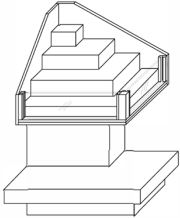
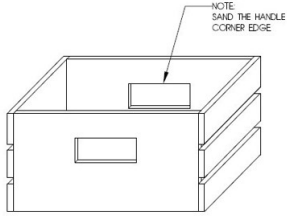

GSK	99535551	GSK	99535553	GSK	98234600	GSK	98215200
우든 아일랜드형 곤돌라(유리 쉘빙) / RACK-2 WOODEN ISLAND GONDOLA GLASS SHELVING-1118X355.6X1397 / WOODEN+GLASS		우든아일랜드형곤돌라/RACK-4 WOODEN ISLAND GONDOLA - 1524X559X1270-D-1 변형모델		a16073000ux1106/곤돌라고정핀 / UXCELL PLASTIC HOLE AUTO SCREW FASTENER RIVET RETAINER / dia 7.6mm(100ea/cs)		KL-CDYBR-SET-RAL7038/캔디바 곤돌라세트/CANDY BAR GONDOLA SET w/LED LIGHT-820Wx455Dx1359Hmm/gray	
							
주문단위	EACH	입수량	1	주문단위	EACH	입수량	1
							
99535551		99535553		98234600		98215200	
GSK	98215201	GSK	98215202	GSK	98100127		
KL-CDYBR-SET-RAL9010/캔디바 곤돌라세트/CANDY BAR GONDOLA SET w/LED LIGHT-820Wx455Dx1359Hmm/white		KL-CDYBR-SET-RAL 8014/캔디바곤돌라세트/CANDY BAR GONDOLA SET w/LED LIGHT-820Wx455Dx1359Hmm/cooper brown		곤돌라사이드펜스엔드유닛용/NEW GONDOLA GRID PANEL(SIDE FENCE) FOR END GONDOLA-copper brown/48"x19"x84"(2ea/cs)			
							
주문단위	SET	입수량	1	주문단위	SET	입수량	1
							
98215201		98215202		98100127			

EQUIPMENT

- PRODUCE BIN & ORCHARD BIN















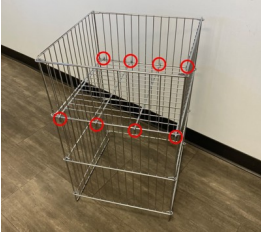
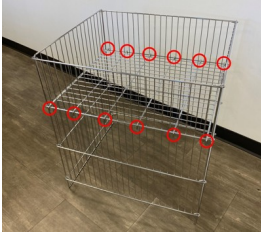

GSK	98100018			GSK	98100019			GSK	98100022			GSK	98249900		
프로듀스빈라이너계단식 /PRODUCE BIN LINER STAIR TYPE A-36"x36"x54" /raccoon fur color				프로듀스빈코너계단식/PRODUCE BIN CORNER STAIR TYPE A- 36"x36"x54" /raccoon fur color/(ea)				프로듀스빈악세서리박스 /PRODUCE BIN'S ACCESSORY BOX-18"(l)x16"(w)x8"(h)				청과매대 A,B Type 앞유리 /PRODUCE BIN LINER TYPE A,B FRONT DIVIDER GLASS- 34.5"x8"x0.5"			
															
주문단위	EACH	입수량	1	주문단위	EACH	입수량	1	주문단위	EACH	입수량	1	주문단위	EACH	입수량	1
 98100018				 98100019				 98100022				 98249900			

























GSK	98100030			GSK	97098007			GSK	97098010		
오차드빈C2배수구&스토리지문 /ORCHARD BIN TYPE C2 WITH SINK HOLE&DOOR-raccoon fur color /36"x36"x33"h				94565/나무정리박스/CRATES AND PALLET WOOD CRATE- 18"x12.5"x9.5" /large				69002/나무정리박스/CRATES AND PALLET WOOD CRATE- 18Dx12.5Wx9.5H" /large /weathered gray			
											
주문단위	EACH	입수량	1	주문단위	EACH	입수량	1	주문단위	EACH	입수량	1
 98100030				 97098007				 97098010			

EQUIPMENT





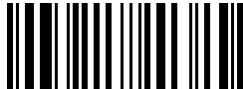



- EQUIPMENT ETC











GSK	98254903	GSK	98254902	GSK	98254900	GSK	98211924
NEW로고크라우드베리어/NEW STACKABLE BARRIER with H-MART LOGO BELT+WHEEL-red/dia 63mm pole/350mm base/6.7ftx2"		NEW컨트롤사인프레임/CONTROL SIGN FRAME LETTER SIZE NEW TYPE BARRIER ACCESSORIES- 216x279mm		크라우드베리어월마운트키트 /CROWD BARRIER WALL MOUNT KIT		WB708418RD/자석베리어 /MAGNETIC RETRACTABLE BELT BARRIER/black case red belt-15W'	
							
주문단위	EACH	입수량	1	주문단위	EACH	입수량	1
							
GSK	98203906	GSK	98246900	GSK	98246901	GSK	97999946
체크아웃카운터베리어월마운트키트 /CHECKOUT COUNTER MAGNETIC BARRIER WALL MOUNT KIT		JWY-01/와이어빈/WIRE BIN-small/chrome/17.6"x17.6"x30"/dia 5.8mm(3ea/cs)		JWY-02/와이어빈/WIRE BIN-medium/chrome/24"x28"x32"/dia 5.8mm(2ea/cs)		H-1825G/유보트/U-BOAT PLATFORM TRUCK-16 X 60"-GREEN	
							
주문단위	EACH	입수량	1	주문단위	CASE	입수량	3
							
GSK	97002226	GSK	98205919	GSK	97999945	GSK	97999944
H-1825-SHELF/유보트셸브 /ULINE U-BOAT PLATFORM TRUCK OPTIONAL SHELF-16"x60"/GREEN		H-8996G/유보트캐처/U-BOAT OPTIONAL CARDBOARD CATCHER-16"(w)x36"(h)x17"(d)/green		H-1825SWIVEL/유보트움바퀴 /UBOAT PLATFORM TRUCK CASTER- 4 X2 "		H-1825RIGID/유보트움바퀴 /UBOAT PLATFORM TRUCK POLYURETHANE RIGID CASTER-dia8"/2"(w)	
							
주문단위	EACH	입수량	1	주문단위	EACH	입수량	1
							









GSK	98216010	GSK	97002463	GSK	97001219	GSK	98205940
김밥기계오일/SUZUMO SOFTON PLUS OIL SPRAY/300ml		H-4808GR/유라인더블티어락커/U LINE DOUBLE TIER LOCKERS-36"x12"x72"		H-5549/유라인락커/ULINE THREE TIER LOCKERS-36" WIDE-GR-36Wx18Dx72H"		H-7586T/유라인락커/ULINE THREE TIER LOCKERS UNASSEMBLED-45Wx18Dx72H"/Tan	
							
주문단위	EACH	입수량	1	주문단위	EACH	입수량	1
							
98216010		97002463		97001219		98205940	
GSK	97003211	GSK	97003377	GSK	98205955	GSK	96324558
H-8343/유라인포티어락커/ULINE FOUR TIER LOCKERS-36"x18"x72"		H-1393AGR/락커/INDUSTRIAL LOCKER SIX TIERS-36"x18"x72"		H-5551/6칸락커(윈도우)/ULINE CLEAR VIEW LICKER-2tier/3wide/36Wx18Dx72H"/tan		109CARTBLGBL/3단카트/CHOICE UTILITY CART W/3 SHELVES-42Lx20Wx38H"/blue	
							
주문단위	EACH	입수량	1	주문단위	EACH	입수량	1
							
97003211		97003377		98205955		96324558	
GSK	96324559	GSK	98210912	GSK	98001112	GSK	96324560
109CARTBLGBK/3단카트/CHOICE UTILITY CART W/3 SHELVES-42Lx20Wx38H"/black		109CARTBLGGY/3단카트/CHOICE UTILITY CART W/3 SHELVES-42Lx20Wx38H"/gray		109CARTBUSBK/3단카트/CHOICE UTILITY CART W/3 SHELVES-32Lx16Wx38H"/black		109CARTCST01/3단카트바퀴/CHOICE SWIVEL CASTER FOR BUSSING AND UTILITY CARTS NO BRAKE-4"	
							
주문단위	EACH	입수량	1	주문단위	EACH	입수량	1
							
96324559		98210912		98001112		96324560	

GSK	96324561	GSK	98211908	GSK	98258900	GSK	98100909
109CARTCST02/3단카트바퀴 /CHOICE SWIVEL CASTER FOR BUSSING AND UTILITY CARTS W/ BRAKE-4"		WB640788/솔트스프레더/GLOBAL INDUSTRIAL UNIVERSAL SPREADER- 27"(w)x40"(l)x32"(h)/100lb capacity		VP-RS50BG/재설용소금 /VAPORIZER NATURAL SODIUM CHLORIDE ROCK SALT ICE MELT SALT-50lb		6000BR/핸드트럭/TWIN-HANDLE HAND TRUCK-500lbs/nose plate 18" wide/wheel type 8"x1.5" moldon rubber/50"Hx18"Wx18"D	
							
주문단위	EACH	입수량	1	주문단위	EACH	입수량	1
							
96324561		98211908		98258900		98100909	

GSK	98100811	GSK	98246910	GSK	98246911	GSK	95124161
PTH50-027-48-1C/크라운 팔렛 잭/CROWN PALLET TRUCK		SW-2FL/2단접이식사다리/SW H-MART LOGO 2 STEP FOLDING LADDER-77"Hx45"Wx54.5mm"D		SW-3FL/3단접이식사다리/SW H-MART LOGO 3 STEP FOLDING LADDER-102"Hx45"Wx72mm"D		H-2661/맥라이너핸드트럭 /MAGLINER STANDDARD ALUMINIUM HAND TRUCK- 14 X 7 1/2" 8" SOLID RUBBER	
							
주문단위	EACH	입수량	1	주문단위	EACH	입수량	1
							
98100811		98246910		98246911		95124161	

GSK	98205933	GSK	98205935	GSK	98210946	GSK	97003432
H-3377/핸드트럭프레임익스텐션 /FRAME EXTENSION FOR ALUMINIUM HAND TRUCKS for H- 2661-60"		H-1208/핸드트럭노즈익스텐션 /NOSE EXTENSION FOR ALUMINIUM HAND TRUCKS for H-2661-30"		HMK116UAB5CV/듀얼핸들핸드트럭 /MAGLINER STRAIGHT BACK HAD TRUCK WITH DUAL HANDLES- 39Lx18.5Wx60H"		WG334428/맥라이너핸드트럭바퀴 /BALLOON CUSHION WHEEL 101030 FOR MAGLINER HAND TRUCK-10"	
							
주문단위	EACH	입수량	1	주문단위	EACH	입수량	1
							
98205933		98205935		98210946		97003432	

GSK	98201901	GSK	98205934	GSK	99762001	GSK	98100683
1356M/뉴에이지유니버설6단카트 /NEW AGE UNIVERSAL 5 SHELVES CART		H-5007BL/플랫3단유틸리티카트 /ULINE 3-SHLEF UTILITY CART W/FLAT SHELVES-27Lx18Wx34H"		SW-SSP/수산부냉장진열장쟁반 /SEA FOOD OPEN DISPLAY REF. STAINLESS STEEL PAN- 30Lx8Wx2"H(5ea./cs)		HL-M04/신문매대/NEWS PAPER WIRE RACK-19Wx12Dx41H"	
							
주문단위	EACH	입수량	1	주문단위	EACH	입수량	1
							
98201901		98205934		99762001		98100683	

GSK	98100684	GSK	98234910	GSK	98211911	GSK	98211912
HL-H/4단선반메탈진열대/4 SHELF METAL DISPLAY RACK- 24"X10X"56"		CCW-01-005-00003/접이식바리 케이드/EXPANDABLE METAL BARRICADE- 4.72Lx2.36Wx0.5H"/11ft/yellow and black		HE-1660/리틀자이언트유보트 /LITTLE GIANT HIGH END PLATFORM TRUCK- 16Wx60Lx59H"/2000lbs		HE-1660-RS/리틀자이언트셀브유 보트/LITTLE GIANT HIGH END PLATFORM TRUCK W/REMOVABLE SHELF-16Wx60Lx59H"/2000lbs	
							
주문단위	EACH	입수량	1	주문단위	EACH	입수량	1
							
98100684		98234910		98211911		98211912	







GSK	98219911	GSK	98211000	GSK	98211001	GSK	98246912
WHMP-05114/리틀자이언트유보 트바퀴/LITTLE GIANT WHEEL-5"		T9F641287/커머셜청소기 /GLOBAL INDUSTRIAL UPRIGHT VACUUM-13Wx14Dx46.75H"/120 V/8.5A		T9FB2328910/커머셜청소기백 /GLOBAL INDUSTRIAL REPLACEMENT BAG FOR UPRIGHT VACUUMS-6Wx4H"		SW-SS/수산부미끄럼방지작업발 판/304 STAINLESS STEEL STEP STAND-150Lx45Dx30Hcm	
							
주문단위	EACH	입수량	1	주문단위	EACH	입수량	1
							
98219911		98211000		98211001		98246912	



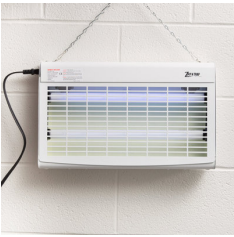
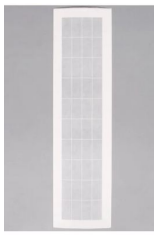
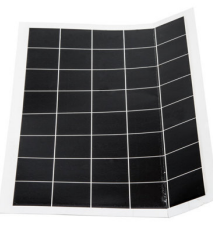



GSK	98246914	GSK	98246913	GSK	98100239	GSK	98100251
SW-RUW/우산랙/SW-DISPLAY RACK for UMBRELLA-45Dx60Lx167Hcm/white		SW-5TRS/5층스피너랙/5TIER SPINNER DISPLAY RACK-56Dx165Hcm/black		96134BH/2단카트/NEW AGE 700LB PLATFORM TRUCK BUSSING UTILITY CART METAL-41.5"(L)x46"(W)x19"(H)		NEW AGE C453/2단카트바퀴/NEW AGE 96134BH CASTER-1 1/4"W - 225LB CAP	
							
주문단위	EACH	입수량	1	주문단위	EACH	입수량	1
							
98246914		98246913		98100239		98100251	
GSK	91098040	GSK	98203900	GSK	98203901	GSK	98203902
XT098/유보트벨/ALUMINUM BICYCLE BELL LOUD CRISP CLEAR SOUND-?2.3"x2"x2.3"/black		KEYBOARD STAND for Suzhou Keshun CHECKOUT COUNTER ACCESSORY-black		SCREEN STAND (MONITOR STAND) for Suzhou Keshun CHECKOUT COUNTER ACCESSORY-black		CREDIT CARD STAND (PIN PAD STAND) for Suzhou Keshun CHECKOUT COUNTER ACCESSORY-black	
							
주문단위	EACH	입수량	1	주문단위	EACH	입수량	1
							
91098040		98203900		98203901		98203902	
GSK	98215690	GSK	98234946	GSK	98234947	GSK	97003379
KL-GRWL-R8014/GRID WALL-4'x4'/RAL8014		DWA2T40IR/드라이버비트세트/DEWALT SCREWDRIVER BIT SET 4.69"(40EA/CS)		DCD800D2/전동드릴키트/DEWALT CORDLESS DRILL KIT/20V,brushless,2batteries, charger,bag-?6.37Lx2.5Wx8.14"H		H-177/ 눈금저울/ ULINE PLATFORM DIAL SCALE-platform size10.25"x10.25"/70lbsx4oz	
							
주문단위	EACH	입수량	1	주문단위	EACH	입수량	1
							
98215690		98234946		98234947		97003379	



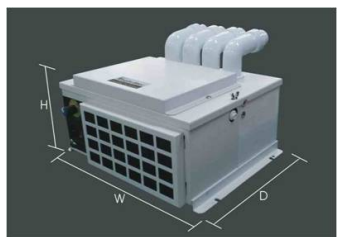
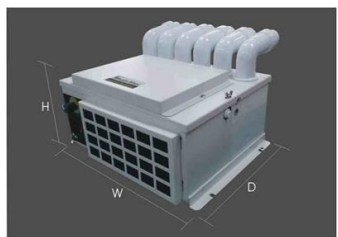





EQUIPMENT

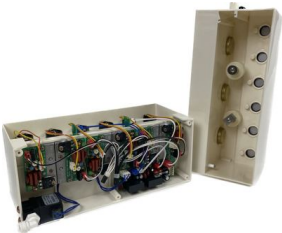







- ELECTRONIC



GSK	96303840	GSK	96340124	GSK	96303841	GSK	96340242
605GT30W/뉴파리잡는기계클루타입/Zap N Trap White Insect Light Trap with Glue Board - 30W		605GBV36/파리잡는기계클루보드-예전모델/ZAP N TRAP GLUE BOARD REFILL for 605BZ80MAG-19 1/4" X 5" (6ea/pk)		605GB1810/파리잡는뉴기계클루보드/ZAP N TRAP-18" X 10" - GLUE BOARD REFILL for 605GT30W-(6/PACK)		60540WUVMAG/파리잡는기계전구-예전모델/Zap N Trap UV Insect Zapper 24" Bulb for 605BZ80MAG-120v/40watt	
							
주문단위	EACH	입수량	1	주문단위	PACK	입수량	6
							
96303840		96340124		96303841		96340242	

GSK	96340243	GSK	98000002	GSK	98000001	GSK	98000005
60515WATT/뉴파리잡는기계전구/ZAP N TRAP 18" STRAIGHT TUBE for 605GT30W- 15W UV BULB		QTS005/매장용초음파가습기4구 H-3.0/ HUMIDIFER-(ea)		QTS005/매장용초음파가습기6구 H-3.0/HUMIDIFER-(ea)		QTS005/매장용초음파가습기정수 필터/WATER FILTER-(25ea/cs)	
							
주문단위	EACH	입수량	1	주문단위	EACH	입수량	1
							
96340243		98000002		98000001		98000005	

GSK	98000006	GSK	98000007	GSK	98000008	GSK	98000009
QTS005/매장용초음파가습기부품 .기판,진동자,송풍기,솔밸브 /FREEPARTS		QTS005/매장용초음파가습기부품 진동자/HUMIDIFER PART		QTS005/매장용초음파가습기부품 진동자기판/HUMIDIFER PARTS-(100ea/cs)		QTS005/매장용초음파가습기부품 분무기조절기/HUMIDIFER PARTS	
							
주문단위	EACH	입수량	1	주문단위	EACH	입수량	1
							
98000006		98000007		98000008		98000009	





















GSK	98000010	GSK	98238902	GSK	85404012	GSK	98234901
QTS005/매장용초음파가습기부품 파워서플라이/HUMIDIFIER POWER PART-(10ea/cs)		SY-1504/신영그린파질기/SHIN YOUNG SCLLION SHREDDER- 440mm(w)x225mm(l)x355mm(h)/110 v, 60hz		RT22/유키토키/RETEVIS RT22 WALKIE TALKIES TWO WAY RADIO -BLACK-(10ea/pk)		EM720CPL-PMB/전자레인지 /COMFEE' COUNTERTOP MICROWAVE OVEN- black/17.3"x13"x10.2"/0.7cu.ft./11 0v/700w	
							
주문단위	CASE	입수량	10	주문단위	EACH	입수량	1
							
98000010		98238902		85404012		98234901	

GSK	98234902	GSK	96304209	IMPERIAL	86304207	GSK	95421103
AU1230XA/종이파쇄기/AURORA ANTIJAM PAPER SHREDDER		HS625A/래핑기계/HEAT SEAL SINGLE 18" ALEX MOUNTED TABLE TOP WRAPPING MACHINE-115V, 748W		HSBAR/래핑기계바/WRAPPING MACHINE BAR		TC615B/615래핑기계덮개/HEAT SEAL GENUINE PARTS NON-STICK WRAPPING MACHINE COVER- 6Wx15H"	
							
주문단위	EACH	입수량	1	주문단위	EACH	입수량	1
							
98234902		96304209		86304207		95421103	









GSK	98265900	GSK	98238009
KT-LED115PSHD-V-EX39-8CSB- D/HID LED 전구/KEYSTONE HID LED HIGH BAY LAMP/115&95&90w/120-277v		98238009-LCC-105 B/럭키김밥 절단기 타입(12등분)/LUCKY HIGH QUALITY SUSHI ROLL CUTTER B TYPE- 370Lx410Wx610Hmm/ac110-	
			
주문단위	EACH	입수량	1
			
98265900		98238009	

ETC



IMPERIAL	85191904	IMPERIAL	85212212	IMPERIAL	85412000	IMPERIAL	85421107
97LINER/팔렛커버,PALLET COVER,52"x45"x97"/clear repro liver(50ea/rl)		MONARCHR/프라이스건레이블 /PRICE GUN LABEL- 3/4x7/16"/red(17000ea/pk)(Mon arch)		SHIELD.DS5000/화장실용종이덮개 /TOILET SEAT COVER HALF-FOLD		FT10801W/플라스틱커버테이블보 /PLASTIC TABLE COVER- 54"x108"/white(12ea/cs)	
							
주문단위	CASE	입수량	50	주문단위	ROLL	입수량	17000
주문단위	CASE	입수량	250	주문단위	CASE	입수량	12
							
85191904		85212212		85412000		85421107	
IMPERIAL	85562103	IMPERIAL	85629910	IMPERIAL	86304207	IMPERIAL	86319001
CM240/세니타이저테스트스트립 /SANITIZER TEST STRIP-15"/10 - 200 PPM		UO/래핑기계미네랄오일 /WRAPPING MACHINE OIL/TASTELESS/MINERAL-1gal		HSBAR/래핑기계바/WRAPPING MACHINE BAR		MON-G/프라이스레이블건 /MONARCH LABEL GUN	
							
주문단위	EACH	입수량	1	주문단위	EACH	입수량	1
주문단위	EACH	입수량	1	주문단위	EACH	입수량	1
							
85562103		85629910		86304207		86319001	
GSK	95421993	GSK	96360002	GSK	97010734	GSK	97005061
고무도마/CUSTOM SIZE POLY CUTTING BOARD/WHITE		HA-1402-JP/일제업소용돌림식채 칼/Benriner Vegetable Turning Slicer-10.55 "L *4.53" W*6.5 "H		RCP627777/미끄럼방지싸인판 /Rubbermaid Commercial Four-Sided Caution, Wet Floor Safety Cone- 10 1/2w x 10 1/2d x 25 5/8h- Yellow		RCP611200YW/미끄럼방지싸인판 /Rubbermaid Commercial Multilingual "Caution" Floor Sign Plastic-11 x 1 1/2 x 26-Bright Yellow	
							
주문단위	EACH	입수량	1	주문단위	EACH	입수량	1
주문단위	EACH	입수량	1	주문단위	EACH	입수량	1
							
95421993		96360002		97010734		97005061	

GSK	97999682	IMPERIAL	85562109	IMPERIAL	85562108	GSK	95533001
S-20628/흡수제/UNIVERSAL SORBENT SOCKS HEAVY DUTY- 3"x12'(4ea/cs)		32OZ 스프레이 통 PLASTIC BOTTLE (ONLY) (BOTTLE32)		32TRIGGER/스프레이방아쇠 /SPRAY TRIGGER BOTTLE32		HD64DBJ/주스통/JUICE BOTTLE- 64OZ/white(108ea/cs)	
							
주문단위	CASE	입수량	4	주문단위	EACH	입수량	1
							
97999682		85562109		85562108		95533001	

GSK	93451002	GSK	93451003	GSK	93451004	GSK	95598016
H-MART로고풍선/H-MART LOGO BALLOON-red(100ea/pk)		H-MART로고풍선/H-MART LOGO BALLOON-blue(100ea/pk)		H-MART로고풍선/H-MART LOGO BALLOON-white(100ea/pk)		OC9S01/미끄럼주의안내판 /SAFETY CONE CAUTION PLASTIC POP-UP CONE-30"/yellow	
							
주문단위	PACK	입수량	100	주문단위	PACK	입수량	100
							
93451002		93451003		93451004		95598016	

GSK	95598017	GSK	91098044
FG9S0000YELB/미끄럼주의안내판 /FLOOR SIGN CAUTION PLASTIC POP-UP CONE MULTILINGUAL- 2.5x21x20"/yellow		B0BM9S3MBD/응급상처बंध합밴드 /RHINO RESCUE ZIP STITCH WITH WOUND DRESSINGS- 9.21x9.02x2.01"/white(6ea/cs)	
			
주문단위	EACH	입수량	1
			
95598017		91098044	



GRAND SK CORP

33 WHELAN ROAD,
EAST RUTHERFORD, NJ 07073
TEL. 201-933-0037(2701 ~2709) FAX. 201-933-4553

gsksupply@hmart.com
gskequipment@hmart.com