



GRAND SK

**OPEN STORE KIT
E-CATALOGUE**

STORE SUPPLY



























GSK	95104025	GSK	95104062	GSK	95231908	GSK	95202276
H-MART 쇼핑백/H-MART PLASTIC SHOPPING BAG- 12x7x20.75"/hdpe/16.5mic/15.21lb (1000ea/cs)		H-MART 종이쇼핑백/H-MART PAPER NATURAL KRAFT BAG- 12X17X7"/85gsm/(500ea/cs)		HMART계산부영수증롤/THERMAL REGISTER TAPE ROLL,3- 1/8x279',BPA FREE/55GSM,(50rl/cs)		41212/유페이프라이스레이블 /YOU PAY PRICE THERMAL LABEL- 3x1.125"/yellow(400ea/30rl/cs)	
							
주문단위	CASE	입수량	1000	주문단위	CASE	입수량	500
주문단위	CASE	입수량	1000	주문단위	CASE	입수량	50
							
95104025		95104062		95231908		95202276	
GSK	95202277	GSK	95222076	GSK	95512006	IMPERIAL	85512008
페이스트티커/PAID STICKER- 51x16mm(1000ea/20rl/cs)		아웃오브스탁태그/TEMPORARILY OUT OF STOCK POLYESTER TAG- 3.1x 2.63"(200ea/pk)		7218DS/퓨렐자동핸드세넨타이저 스탠드디스펜서/PURELL AUTO HAND SANITIZER FLOOR STAND DISPENSER FOR PURELL775302		PURELL775302/퓨렐자동핸드세넨 타이저리필/PURELL AUTO HAND SANITIZER REFILL-1200ml(2ea/cs)	
							
주문단위	CASE	입수량	20000	주문단위	PACK	입수량	200
주문단위	CASE	입수량	20000	주문단위	EACH	입수량	1
							
95202277		95222076		95512006		85512008	
GSK	95512009	IMPERIAL	85512010	IMPERIAL	85123212	IMPERIAL	85539001
LO5572/핸드솜수동디스펜서/VB HAND SOAP MANUAL DISPENSER FOR LO5501-white		LO5501/핸드솜수동리필/VB HAND SOAP MANUAL REFILL-1200ml(4ea/cs)		FC103/3상섬유접시/3 COMP FIBER PLATE-10"/white/(500ea/cs)		DU5006501/품보울/BOWL FOAM WHT RND UNLAMINATED-12oz(1000ea/cs)	
							
주문단위	EACH	입수량	1	주문단위	CASE	입수량	4
주문단위	EACH	입수량	1	주문단위	CASE	입수량	500
							
95512009		85512010		85123212		85539001	

IMPERIAL	85422001	IMPERIAL	85422020	GSK	93061001	GSK	95561215								
P2SSH/손가락/SPOON HVY DUTY(1000ea/cs)		P2FH/포크헤비/FORK HEAVY(1000ea/cs)		코팅장갑/COATING GLOVES-10*36-red/73031103(360ea/cs)		SNM50005../블루니트릴장갑/BLUE NITRILE DISPOSABLE NITRILE PF GLOVE POWDER FREE-small(100ea/10pk/cs)									
															
주문단위	CASE	입수량	1000	주문단위	CASE	입수량	1000	주문단위	CASE	입수량	360	주문단위	CASE	입수량	1000
															
85422001		85422020		93061001		95561215									
GSK	95561217	IMPERIAL	85562108	IMPERIAL	85562109	GSK	96340125								
SNM50015/블루니트릴장갑/BLUE NITRILE DISPOSABLE NITRILE PF GLOVE POWDER FREE-large(100ea/10pk/cs)		32TRIGGER/스프레이방아쇠 /SPRAY TRIGGER BOTTLE32		32OZ 스프레이 통 PLASTIC BOTTLE (ONLY) (BOTTLE32)		ETD/계산대막대기/H MART LOGO ETD CASHIER DIVIDER-16"/red									
															
주문단위	CASE	입수량	1000	주문단위	EACH	입수량	1	주문단위	EACH	입수량	1	주문단위	EACH	입수량	1
															
95561217		85562108		85562109		96340125									
GSK	96336116	GSK	96336117	GSK	96340119	GSK	96340365								
쇼핑바스켓홀더 w/바퀴 /SHOPPING BASKET HOLDER W/WHEELS-2"- 4wheels w/2break for XJL-12/460Lx325Wx350Hmm		XJL-12/쇼핑바스켓/H-MART LOGO SHOPPING BASKET-red/19"Wx13"Dx10.5"H/480Lx330 Wx265Hmm/28L(25ea/cs)		계산대CLOSED싸인/LANE CLOSED SIGN-10"x6-1/2"		SW-SS/싸인스탠드/HEAVY DUTY SIGN STAND SNAP OPEN FRAME VERTICAL HORIZONTAL-8.5"x11"/34"to48"tall/black(5ea/cs)									
															
주문단위	EACH	입수량	1	주문단위	CASE	입수량	25	주문단위	EACH	입수량	1	주문단위	CASE	입수량	5
															
96336116		96336117		96340119		96340365									









GSK	96340702	GSK	96900011	GSK	96900012	GSK	96900013
스마트카드광고계산대디바이더 /HMART SMART CARD AD CHECKOUT COUNTER DIVIDER— 15.8X3.8"(50ea/cs)		PMP106441/POP종이커버/MEDIUM POP POCKET— 8Lx3"H/medium(50ea/pk)		PSP106440/POP종이커버/SMALL POP POCKET— 4Lx3"H/small(50ea/pk)		PLF 106835/POP커버대/LARGE POP POCKET—11"x8— 1/2"(100ea/cs)	
							
주문단위	CASE	입수량	50	주문단위	PACK	입수량	100
							
GSK	96900021	GSK	96900041	GSK	96900061	GSK	96900062
PLB183S104004/POP플라스틱프레임 /LETTER PLASTIC FRAME BASE—5"Wx3"L(25ea/pk)		POP플라스틱 자석프레임/LETTER PLASTIC FRAME MAGNETIC BASE— 1"Wx1— 1/4"Hx3"L(10ea/pk)		1112148301/와이어사인홀더/301 SUPERGRIP WIRE FLUSH SIGN HOLDER—1/2"x1"(100ea/pk)		1112148303/와이어사인홀더/301 SUPERGRIP WIRE FLUSH SIGN HOLDER—1"x3/4"(100ea/pk)	
							
주문단위	PACK	입수량	25	주문단위	PACK	입수량	10
주문단위	PACK	입수량	10	주문단위	PACK	입수량	100
주문단위	PACK	입수량	100	주문단위	PACK	입수량	100
							
GSK	96900081	GSK	96900083	GSK	96900084	GSK	96900085
2800342702/POP포켓&클립 /POCKET WITH CLIP—7x5"		2805693105/POP포켓홀더클립 /POCKET HOLDER CLIP— 4x3"/small(25ea/pk)		2202278001/Letter Size POP사인홀 더/WALL-MOUNT PLAIN SIGN HOLDER—8.5"Wx11"H(25ea/cs)		1601799801/POP클립/POCKET RING—white(100ea/pk)	
							
주문단위	EACH	입수량	1	주문단위	PACK	입수량	25
주문단위	PACK	입수량	25	주문단위	CASE	입수량	25
주문단위	PACK	입수량	100	주문단위	PACK	입수량	100
							

GSK	96900092			GSK	96900140			GSK	95402033			GSK	97000937		
SF-A-118.5/PLS스틸스텝프레임 스탠드/PLS POP LETTER STEEL STEM FRAME-11"x8-1/2"(10ea/cs)				PSSH-72/POP롱스텐드/POP PLL LETTER LONG STAND BASE AND TOP SET(2ea/cs)				GRP36202-BK/일회용검정미끄럼 방지매트/BLACK TRIP FLOOR PIG MAT-36X 5"(10ea/pk)				계산대메모리폼매트/CHECKOUT COUNTER ANTI FATIGUE STANDING MAT W/H-MART DEBOSSED LOGO-32x20"/0.75"thick/solid black			
															
주문단위	CASE	입수량	10	주문단위	CASE	입수량	2	주문단위	PACK	입수량	10	주문단위	EACH	입수량	1
															
96900092				96900140				95402033				97000937			
GSK	92005001			GSK	92005002			IMPERIAL	85505001			IMPERIAL	85105040		
(동부용)RH3660022C/HDPE레굴러 반투명쓰레기백/HDPE GABAGE BAG-36"x60"/22mic/22eq/55gal/white(100ea/cs)				(동부용)ELI386012C/헤비클리어쓰레기백/LDPE XTRA HEAVY DUTY GABAGE BAG-38"x58"/1.0mil/55gal/white(100ea/cs)				R3037N12/20-30gal/클리어쓰레기백/VB CAN LINER NAT-30x37"(500ea/cs)				VCX3658XX/검정쓰레기백(LDPE)/BLACK GARBAGE BAG VCX3658XX, MAX58 (CXP3658XX, PG6-5860)-1.12mil55gal(100ea/cs)			
															
주문단위	CASE	입수량	100	주문단위	CASE	입수량	100	주문단위	CASE	입수량	500	주문단위	CASE	입수량	100
															
92005001				92005002				85505001				85105040			
GSK	96900074			GSK	96900075			GSK	96900076			GSK	96292901		
POP오렌지컬러종이/POP COLOR PAPER COSMIC ORANGE-8 x 3"/89g,24lb(500ea/pk)				POP블루컬러종이/POP COLOR PAPER LUNAR BLUE-8 x 3"/89g,24lb(500ea/pk)				POP옐로우컬러종이/POP COLOR PAPER SOLAR YELLOW-8 x 3"/89g,24lb(500ea/pk)				SW-PLC/플라스틱프라이스레이블 커버/SHELF STRIP PRICE LABEL PLASTIC COVER(250ea/pk)			
															
주문단위	PACK	입수량	500	주문단위	PACK	입수량	500	주문단위	PACK	입수량	500	주문단위	PACK	입수량	250
															
96900074				96900075				96900076				96292901			

GSK	95402532	GSK	95402533	IMPERIAL	85398101	IMPERIAL	85398102								
H-4565/가격레이블건/MONARCH 1136 ALPHA/NUMERIC LABEL GUN - TWO LINE-monarch label 3/4"x5/8"/gray		S-7978W/가격레이블/MONARCH 1136 LABELS- 3/4"x5/8"/white(1750ea/8rl/cs)		CRFCUT/박스칼/BOX CUTTER- 3"X1"(12ea/cs)		CRFBLD/박스칼용칼날/BLADE FOR BOX CUTTER(100ea/cs)									
															
주문단위	EACH	입수량	1	주문단위	CASE	입수량	8	주문단위	CASE	입수량	12	주문단위	CASE	입수량	100
															
GSK	99583000	W.B.	97001538	IMPERIAL	85191902	GSK	99535318								
45M-H2/우림클리어박스테이프 /CLEAR POLY BOX TAPE- 48mmx45m/65MIC(50ea/cs)		WBMTD2/테이프디스펜서/Tape Logic Work Horse Carton Sealing Tape Dispenser, 2", Blue/White		1514GA/종이박스철사/BAILING WIRE FOR CARDBOARD-15' 14gage(250ea/cs)		SW-LU/H-MART 로고장우산 /EXTENDABLE UMBRELLA H-MART LOGO TF-1360 AUTO HANDLE-orange&white/F9022-55.5"(12ea/pk)									
															
주문단위	CASE	입수량	50	주문단위	EACH	입수량	1	주문단위	CASE	입수량	250	주문단위	PACK	입수량	12
															
GSK	97999868	GSK	97999863	IMPERIAL	85401013	IMPERIAL	85401018								
SW-G-L/H-MART 유니폼조끼 /H-MART UNIFORM VEST- large/green(15ea/pk)		SW-O-L/H-MART 유니폼조끼 /H-MART UNIFORM VEST- large/orange(15ea/pk)		136STKB/물밀대&창고브러시 자루 /SQUEEGEE&BRUSH HANDLE-60"		18GB/창고브러시/GARAGE BRUSH-18"(10818BRM)									
															
주문단위	PACK	입수량	15	주문단위	PACK	입수량	15	주문단위	EACH	입수량	1	주문단위	EACH	입수량	1
															

IMPERIAL	85402099	IMPERIAL	85401017	IMPERIAL	85404441	IMPERIAL	85404432
226311YW/마포짜는통/206-31YW MOP BUCKET-26qt		24GB/창고브러시/GARAGE BRUSH-24"(136STK/GARAGE CLEANING/10824GB)		264560/쓰레기통뚜껑/RUBBERMAID RESIN FLAT LID/gray/round/body:4444GY		3200GY/쓰레기통/TRASH CAN-32GAL	
							
주문단위	EACH	입수량	1	주문단위	EACH	입수량	1
							
85402099		85401017		85404441		85404432	
IMPERIAL	85404447	IMPERIAL	85402032	IMPERIAL	85404444	IMPERIAL	85402091
3201GY/쓰레기통뚜껑/TRASH CAN LID,32 GAL-RAY/ROUND/3200GY/CONTINENTAL,(1/CS)-2631RM		32DDMP/마포#32/COTTON MOP HEAD		4444GY/쓰레기통/TRASH CAN-44gal-gray-round-2645RM/CONTINENTAL		608HANDLE/마포자루/MOPSTICK FIBERGLASS	
							
주문단위	EACH	입수량	1	주문단위	EACH	입수량	1
							
85404447		85402032		85404444		85402091	
IMPERIAL	85404446	IMPERIAL	85401010	IMPERIAL	85404022	IMPERIAL	85406031
7325GRY/쓰레기통뚜껑/LID GRAY SWING -23gal		91351/빗자루/DUO-SWEEP BROOM-13x48"		96826/물밀대/WATER SQUEEGEE HEAD, -22"(136STK/HEAD ONLY)		97000/쓰레기통바퀴받침/TRASH CAN DOLLY ROUND-gray	
							
주문단위	EACH	입수량	1	주문단위	EACH	입수량	1
							
85404446		85401010		85404022		85406031	

























IMPERIAL	85402024	IMPERIAL	85406016	IMPERIAL	85401026	IMPERIAL	85402081
97156/마포걸레/MAXICLEAN MOP BLUE-24oz		B452/쓰레받기/LOBBY DUST PAN-12"-SWIVEL		BR-605-10/데크브러쉬/DECK BRUSH-10",HANDLE: 125STK		DM245/기름걸레/DUST MOP HEAD-24"x5"	
							
주문단위	EACH	입수량	1	주문단위	EACH	입수량	1
							
85402024		85406016		85401026		85402081	
IMPERIAL	85402082	IMPERIAL	85402084	GSK	97999923	GSK	97001465
DM365/기름걸레/DUST MOP HEAD-36"x5"		DM485/기름걸레/DUST MOP HEAD-48"x5"		H-1336/재니터카트/Rubbermaid Standard Janitor Cart- 22" X 46" X 38"		H-5148GR/23갤런쓰레기통/ULINE THIN TRASH CAN-23 GAL-GRAY	
							
주문단위	EACH	입수량	1	주문단위	EACH	입수량	1
							
85402082		85402084		97999923		97001465	
GSK	98000300	GSK	95408066	IMPERIAL	85139535	IMPERIAL	85139536
H-6089/청소용품홀더/QUICK ADJUSTABLE MOP BROOM HOLDER-20"		H-7867BL/청소도구보관대 /GARAGE TOOL HOLDERS/black		SN524/기름걸레프레임/DUST MOP FRAME- 24"x5"/black/metal		SN536/기름걸레프레임/DUST MOP FRAME-36"x5"/black/metal	
							
주문단위	EACH	입수량	1	주문단위	EACH	입수량	1
							
98000300		95408066		85139535		85139536	



IMPERIAL	85402085	IMPERIAL	85402083	GSK	95629901	GSK	95407021								
SN548/기름걸레프레임/DUST MOP FRAME-48"X5"/black/metal		SNSTK/기름걸레자루/DUST MOP HANDLE-60"		JOY/주방세제/POT&PAN DETERGENT-38oz/yellow(8ea/cs)		10652/핑크식기세제/PINK POT N PAN DETERGENT SO KLEEN PINK LIQUID-1gal(4ea/cs)									
															
주문단위	EACH	입수량	1	주문단위	EACH	입수량	1	주문단위	CASE	입수량	8	주문단위	CASE	입수량	4
															
85402085		85402083		95629901		95407021									
GSK	95407026	GSK	95407028	IMPERIAL	85402023	IMPERIAL	85507005								
10994/핑크핸드솜/PINK STAR HAND SOAP-1gal(4ea/cs)		21001/윈도우클리너/WINDOW CLEANER-1gal(4ea/cs)		4DM/바닥청소세제/DAMP MOP CLEANER-1 GAL(4ea/cs)		4INSPECT/기름제거제/DEGREASER-1gal(4ea/cs)									
															
주문단위	CASE	입수량	4	주문단위	CASE	입수량	4	주문단위	CASE	입수량	4	주문단위	CASE	입수량	4
															
95407026		95407028		85402023		85507005									
IMPERIAL	85408031	IMPERIAL	85621111	IMPERIAL	85408051	GSK	95403124								
90940/윈덱스유리용클리너/WINDEX GLASS CLEANER-1 gal(4ea/cs)		C18-G/세네타이저세정제/ECOLOGIC SANITIZER-1gal(4ea/cs)		CFCLBR50/가루세제/POWDER DETERGENT		CHLOR-GLO/표백제/BLEACH DISINFECTANT SANITIZER-1gal(4ea/cs)									
															
주문단위	CASE	입수량	4	주문단위	CASE	입수량	4	주문단위	EACH	입수량	1	주문단위	CASE	입수량	4
															
85408031		85621111		85408051		95403124									

GSK	95403127	IMPERIAL	85408042	IMPERIAL	85408045	IMPERIAL	85428017
CLOX30966/클로락스표백제 /CLOROXGERMICIDA BLEACH- 121oz(3bt/cs)		E2-G/기름제거제/DEGREASER ECOLOGIC FOR DISH WASH MACHINE-1gal(4ea/cs)		E45-G/드릴펄/DRAIN&ODOR TREATMENT-1gal(4ea/cs)		E69-5/식기세척기용세제 ECOLOGIC/DISH WASH MACHINE POT&PAN DETERGENT-5gal	
							
주문단위	CASE	입수량	3	주문단위	CASE	입수량	4
							
95403127		85408042		85408045		85428017	
IMPERIAL	85428018	IMPERIAL	85503001	GSK	91007001	GSK	95407029
E69-G/식기세척기용세제 /POT&PAN DETERGENT 1gal ECOLOGIC DISH WASH MACHINE(4ea/cs)		F00044/스프레이유리클리너/VB SPRAY GLASS CLEANER AMMONIATED-32oz (12ea/cs)		QCC-132-1/퀄리티케미컬오븐그 릴클리너/QUALITY CHEMICAL OVEN & GRILL CLEANER- 128oz/1gal(2ea/cs)		SD1182701/바닥광택제/LUSTER PLUS.NO RINSE NEUTRAL FLOOR CLEANER-1gal(4ea/cs)	
							
주문단위	CASE	입수량	4	주문단위	CASE	입수량	12
							
85428018		85503001		91007001		95407029	
GSK	95403128	GSK	95407025				
새니타이저/GREEN KEY SANITIZER-1gal(4ea/cs)		파인바닥 청소제/PINE DEODORANT FLOOR CLEANER-1gal(4ea/cs)					
							
주문단위	CASE	입수량	4	주문단위	CASE	입수량	4
							
95403128		95407025					









PRODUCE SUPPLY

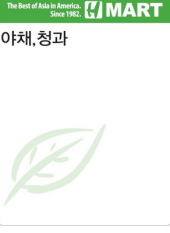







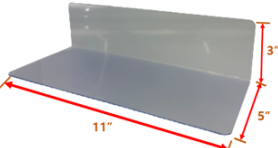

GSK	95101005	GSK	95101200	IMPERIAL	85101150	IMPERIAL	85103006								
HMART 122012/H-MART 로고롤백 /H-MART LOGO ROLL BAG— small/12mic/12x20"(1000ea/4rl/c s)		PSHMART 1824/H-MART 배추롤백 /H-MART LOGO PRODUCE ROLL BAG—LARGE/18x24"(4rl/cs)		RP15HD/로고없는야채롤백(특소)PRODUCE ROLL BAG/10x15"(4rl/cs)		FB6315R/야채폴리백/CLEAR POLY BAG— 6x3x15"— clear(1000ea/cs)									
															
주문단위	CASE	입수량	4	주문단위	CASE	입수량	4	주문단위	CASE	입수량	4	주문단위	CASE	입수량	1000
															
95101005		95101200		85101150		85103006									
GSK	95103150	GSK	95101243	GSK	95101242	GSK	95103110								
C1218XH/폴리백/KIMCHI XHVV POLY BAG— 12x18"/clear(1000ea/cs)		11161/#130야사이폴리백/#13 YASAI POLY BAG/10.25x17"/1mil/clear(1000ea /cs)		11162/#120야사이폴리백/#12 YASAI POLY BAG— 9x13.5"/1mil/clear(1000ea/cs)		C18H/폴리백/10.8lb POLY BAG/clear—8x4x18"(1000ea/cs)									
															
주문단위	CASE	입수량	1000	주문단위	CASE	입수량	1000	주문단위	CASE	입수량	1000	주문단위	CASE	입수량	1000
															
95103150		95101243		95101242		95103110									
IMPERIAL	85104090	GSK	95108010	IMPERIAL	85108052	IMPERIAL	85103140								
18PTB/스시플래터백/CARRY BAG FOR CATERING PLATTER— 18"(50ea/cs)		GRAPENET/그물망백/VEXAR MESH BAG—green/15"(1000ea/cs)		AHL5.5X20G/그물망백/VEXAR MESH BAG— 18"/green/(1000ea/cs)		108DELI/델리백/DELI BAG— 10x8"(1000ea/cs)									
															
주문단위	CASE	입수량	50	주문단위	CASE	입수량	1000	주문단위	CASE	입수량	1000	주문단위	CASE	입수량	1000
															
85104090		95108010		85108052		85103140									

IMPERIAL	85109032	IMPERIAL	85109033	GSK	91010001	GSK	95103190								
10X16CRY/숨쉬는야채백/VENTED FILM BAG-10x16"(1000ea/cs)		11X20CRY/숨쉬는야채백/VENTED FILM BAG-11x20"(1000ea/cs)		442RCHH12154/투명지퍼백/4 ML ZIPPER POUCH BAG -12" x 15" /clear(500ea/cs)		C18XH/더블엑스트라해비폴리백 /2XL HEAVY POLY BAG-clear/8x4x18"/17.20lb(1000ea/cs)									
															
주문단위	CASE	입수량	1000	주문단위	CASE	입수량	1000	주문단위	CASE	입수량	500	주문단위	CASE	입수량	1000
															
85109032		85109033		91010001		95103190									
GSK	95103120	GSK	95103130	GSK	95101204	GSK	95401001								
C24XH/폴리백/POLY BAG-clear/10x8x24"/17.2LB(500ea/cs)		C30H/폴리백/XTRA HEAVY POLY BAG-clear/12"x8"x30"/20lb(250ea/2pk/cs)		PHB-SEAFOOD-LRG/수산부폴리백/LOBSTER LOGO SEAFOOD BAG-12x18"/large(1000ea/cs)		S-10868/폴리백(수산부용)/1 ML POLY BAG-5x24"/clear(1000ea/cs)									
															
주문단위	CASE	입수량	500	주문단위	CASE	입수량	250	주문단위	CASE	입수량	1000	주문단위	CASE	입수량	1000
															
95103120		95103130		95101204		95401001									
GSK	95108020	IMPERIAL	85108050	IMPERIAL	85108053	GSK	95101205								
GRAPENETR/그물망백/VEXAR MESH BAG-15"/red(1000ea/cs)		HBR1245/그물망백/VEXAR MESH BAG-23"/orange/(1000ea/cs)		AHL5.5X20R/그물망백/VEXAR MESH BAG-18"/red(1000ea/cs)		PP-6484-CLEAR/투명토드백 /SOFT LOOP HANDLE CLEAR BAG-6.75"X8.5"(200ea/cs)									
															
주문단위	CASE	입수량	1000	주문단위	CASE	입수량	1000	주문단위	CASE	입수량	1000	주문단위	CASE	입수량	200
															
95108020		85108050		85108053		95101205									

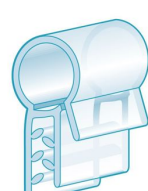
GSK	95102030	GSK	95102032	GSK	95101203	GSK	95101202								
PVGR/그물형포도백/VENTED GRAPE BAG EXTRA HEAVY(1000ea/cs)		BOBEGB/포도그림포도백/GRAPE DESIGN VENTED GRAPE BAG-10.25x11x5.25"(1000ea/cs)		ZIP-1012-CLEAR/청과부구멍난지퍼백(대)/VENTED ZIPPER POUCH BAG WITH HANDLE-BIG-10"x12"(500ea/cs)		ZIP-106.5-CLEAR/청과부구멍난지퍼백(소)/VENTED ZIPPER POUCH BAG WITH HANDLE-SMALL-10"x6.5"(500ea/cs)									
주문단위	CASE	입수량	1000	주문단위	CASE	입수량	1000	주문단위	CASE	입수량	500	주문단위	CASE	입수량	500
95102030		95102032		95101203		95101202									
GSK	95101201	GSK	99742001	GSK	99742000	GSK	95101137								
ZIP-109-CLEAR/청과부구멍난지퍼백(중)/VENTED ZIPPER POUCH BAG WITH HANDLE-MID-10"x9"(500ea/cs)		마봉지/H-MART LOGO CHINESE YAM VENTED BAG-31.5" x 6"/clear(100ea/pk)		우엉봉지/H-MART LOGO BURDOCK VENTED BAG-35.5" x 3.5"/clear(100ea/pk)		C14V/구멍난상추폴리백/8.8lb VENTED POLY BAG CLEAR/LETTUCE-8x4x14"(1000ea/cs)									
주문단위	CASE	입수량	500	주문단위	PACK	입수량	100	주문단위	PACK	입수량	100	주문단위	CASE	입수량	1000
95101201		99742001		99742000		95101137									
GSK	95101138	IMPERIAL	85542001	GSK	91060001	GSK	95101192								
C18V/구멍난폴리백/VENTED CLEAR PER FOR ATED POLY BAG/8x4x18"(1000ea/cs)		321602/햄버거봉투/FOIL LAMINATED BAG HAMBURGER-6Wx6.75L"(1000ea/cs)		B07H513XJZ/꽃다발포장봉투/A&A FLOWER BOUQUET UNPRINTED PLASTIC BAG-37micron/9x14x3.5"/clear(100ea/cs)		설치형롤백디스펜서/ATTACHED TYPE ROLL BAG DISPENSER									
주문단위	CASE	입수량	1000	주문단위	CASE	입수량	1000	주문단위	CASE	입수량	100	주문단위	EACH	입수량	1
95101138		85542001		91060001		95101192									

GSK	95101191	GSK	95151107	GSK	95202271	IMPERIAL	85184016								
스탠드형롤백디스펜서/STAND TYPE ROLL BAG DISPENSER		하이퍼포먼스래핑필름/HIGH PERFORMANCE MEAT FILM- 4012'x18"/17micron/72gauge		40724/디자인청과저울레이블 /DESIGN PRODUCE SCALE LABEL- 2.25x3x1.5"/green(380ea./24rl/cs)		16RB/#16고무줄/ALLIANCE ADVANTAGE RUBBER BAND- #16/red/454g(600ea./pk)									
															
주문단위	EACH	입수량	1	주문단위	EACH	입수량	1	주문단위	CASE	입수량	9120	주문단위	PACK	입수량	600
															
95101191		95151107		95202271		85184016									
IMPERIAL	85183038	GSK	95179584	GSK	95179613	IMPERIAL	85340003								
3/8PVCG/백테이프(야채부)/PVC BAG TAPE- 3/8"X180yds/green		3/605B/청과부바스켓/OBLONG SYNTHETIC WICKER TRAY- 22"x14"x4.5"/light brown		3/608S/청과부바스켓/PRODUCE BASKET- 15L"x16"Dx1.5"to4"H/black		36RUBBER/진열대고무매트 /RUBBER LINER SUPERGRIP- 36"x60"/black									
															
주문단위	EACH	입수량	1	주문단위	EACH	입수량	1	주문단위	ROLL	입수량	1				
															
85183038		95179584		95179613		85340003									
GSK	93061001	GSK	95561216	GSK	92005001	IMPERIAL	85562108								
코팅장갑/COATING GLOVES- 10*36-red/73031103(360ea./cs)		SNM50010/블루니트릴장갑/BLUE NITRILE DISPOSABLE NITRILE PF GLOVE POWDER FREE- medium(100ea./10pk/cs)		(동부용)RH3660022C/HDPE레귤러 반투명쓰레기백/HDPE GABAGE BAG- 36"x60"/22mic/22eq/55gal/white (100ea./cs)		32TRIGGER/스프레이방아쇠 /SPRAY TRIGGER BOTTLE32									
															
주문단위	CASE	입수량	360	주문단위	CASE	입수량	1000	주문단위	CASE	입수량	100	주문단위	EACH	입수량	1
															
93061001		95561216		92005001		85562108									

















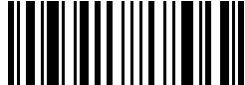





IMPERIAL	85562109	GSK	95460001	GSK	95623003	GSK	96304209
32OZ 스프레이 통 PLASTIC BOTTLE (ONLY) (BOTTLE32)		S-12434/목재완충재/UNDYED ASPEN FINE EXCELSIOR-25lb/wood		78000003/핸드페이퍼타월/HAND PAPER TOWEL- 8"x800"/white(6rl/cs)		HS625A/래핑기계/HEAT SEAL SINGLE 18" ALEX MOUNTED TABLE TOP WRAPPING MACHINE-115V, 748W	
							
주문단위	EACH	입수량	1	주문단위	CASE	입수량	6
							
85562109		95460001		95623003		96304209	



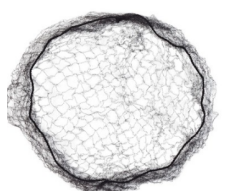















GSK	96340400	GSK	96900011	GSK	96900062	GSK	98112074
SW-PD-1153/짧은플라스틱디바이더/PLASTIC DIMDER- 280/125/75-1.5T/ 11"x5"x3"x1/16"T(100pcs/cs)		PMP106441/POP종이커버/MEDIUM POP POCKET- 8Lx3"H/medium(50ea/pk)		1112148303/와이어사인홀더/301 SUPERGRIP WIRE FLUSH SIGN HOLDER-1"x3/4"(100ea/pk)		MCS-40F/수산부행잉저울 /DETECTO MCS-40F/HANGING SCALE -40LBS CAP	
							
주문단위	CASE	입수량	100	주문단위	PACK	입수량	100
							
96340400		96900011		96900062		98112074	

GSK	96535005
308T25B/청과부저울/CARDINAL DETECTO T25B 25LB- BOWL25LBS	
	
주문단위	EACH
입수량	1
	
96535005	









SEAFOOD SUPPLY























GSK	95103120	GSK	95103150	GSK	95151107	GSK	95160399								
C24XH/폴리백/POLY BAG— clear/10x8x24"/17.2LB(500ea/cs)		C1218XH/폴리백/KIMCHI XHVY POLY BAG— 12x18"/clear(1000ea/cs)		하이퍼포먼스래핑필름/HIGH PERFORMANCE MEAT FILM— 4012'x18"/17micron/72gauge		스시용바란마운틴형/BARAN SUSHI DECORATION(1000ea/pk)									
															
주문단위	CASE	입수량	500	주문단위	CASE	입수량	1000	주문단위	EACH	입수량	1	주문단위	PACK	입수량	1000
															
95103120		95103150		95151107		95160399									
GSK	96360001	GSK	95202272	GSK	95222101	GSK	95222105								
TK-615-02/스시용바란새우형 /VINYL DECORATION LEAF EBI BARAN 2GO MODELLINO(1000ea/pk)		디자인생선저울레이블/DESIGN FISH SCALE LABEL— 2.25x3x1.5"/blue(380ea/24rl/cs)		베스트셀러레이블/BEST SELLER LABEL—2.2x2.2"/Red(500ea/rl)		수산부자반생선레이블/SEAFOOD DEPT SALTED FISH LABEL— 3x2.2"/Gold(1000/RL)									
															
주문단위	CASE	입수량	1000	주문단위	CASE	입수량	9120	주문단위	ROLL	입수량	500	주문단위	ROLL	입수량	1000
															
96360001		95202272		95222101		95222105									
GSK	95340124	IMPERIAL	85404449	IMPERIAL	85429002	GSK	96313305								
플라스틱대나무매트(냉장매대용))/PLASTIC BAMBOO MAT— large/700x1000mm/27.56x39.37"		그물머리망/NYLON HAIRNETS— black(144ea/cs)		DAV08/비닐앞치마/VINYL APRON 1.25MIL—24"x42"/white/(12ea/cs)		Apron—4010/한국앞치마/KOREA PVC APRON—navy									
															
주문단위	EACH	입수량	1	주문단위	CASE	입수량	144	주문단위	CASE	입수량	12	주문단위	EACH	입수량	1
															
95340124		85404449		85429002		96313305									

GSK	92005001	GSK	93061005	GSK	95561214	GSK	95561216								
(동부용)RH3660022C/HDPE레굴러 반투명쓰레기백/HDPE GABAGE BAG- 36"x60"/22mic/22eq/55gal/white (100ea/cs)		마미손고무장갑/MAMISON RUBBER GLOVES- xlarge/red/73033105(100ea/cs)		SNM50020./블루니트릴장갑/BLUE NITRILE DISPOSABLE NITRILE PF GLOVE POWDER FREE-x- large(100ea/10pk/cs)		SNM50010./블루니트릴장갑/BLUE NITRILE DISPOSABLE NITRILE PF GLOVE POWDER FREE- medium(100ea/10pk/cs)									
															
주문단위	CASE	입수량	100	주문단위	CASE	입수량	100	주문단위	CASE	입수량	1000	주문단위	CASE	입수량	1000
															
92005001		93061005		95561214		95561216									
IMPERIAL	85591001	GSK	95923001	GSK	96340365	GSK	95422049								
DLAC50/흡수패드/ABSORBANT PAD-4.75x7"(2600ea/cs)		프리미엄롤페이퍼타월/ PREMIUM PAPER TOWEL-11"x 5.5" (6rl/cs)		SW-SS/싸인스탠드/HEAVY DUTY SIGN STAND SNAP OPEN FRAME VERTICAL HORIZONTAL- 8.5"x11"/34"to48" tall/black(5ea/c s)		KR-12SS/벽면칼집/KNIFE RACK 12 SLOT STAINLESS STEEL									
															
주문단위	CASE	입수량	2600	주문단위	CASE	입수량	6	주문단위	CASE	입수량	5	주문단위	EACH	입수량	1
															
85591001		95923001		96340365		95422049									
GSK	96363101	GSK	96363201	GSK	96363303	GSK	96363304								
SS-1211/숫돌/COMINATION SHARPENING STONE		FSP-9/스테인리스스케일러 /STAINLESS SCALER		KK16/핀보너/PIN BONER STAINLESS STEEL		9661000/2498-KE/수산부가위 /FISHSCISSORS-10"									
															
주문단위	EACH	입수량	1	주문단위	EACH	입수량	1	주문단위	EACH	입수량	1	주문단위	EACH	입수량	1
															
96363101		96363201		96363303		96363304									

GSK	99599004			GSK	96363102			GSK	96313024			GSK	96313004		
RBC-SW11-10/금해여름장화 /SUMMER LONG BOOTS- us10/280cm/navy				85092/와이어브러시/WIRE BRUSH/PLAT cs WIRE BLOCK TR- 5x10x1-1/4"				02503/염도측정기/ HYDROMETER- 15"x6"xx8"				11212H/생선용스플리터/FISH SPLITTER-12"			
															
주문단위	EACH	입수량	1	주문단위	EACH	입수량	1	주문단위	EACH	입수량	1	주문단위	EACH	입수량	1
															
99599004				96363102				96313024				96313004			

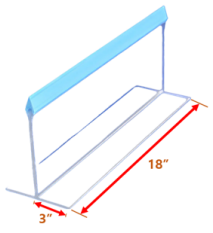
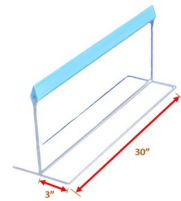
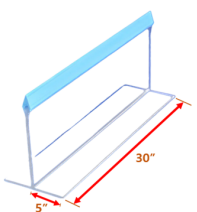
GSK	91062005			GSK	96363302			GSK	96363400			GSK	96363401		
4070229/수산부스텐레스작은팬트 레이/CHOICE HALF SIZE ANTI JAM TABLE PAN TRAY- 10.5Wx2.5Hx12.75L"/stainless				69825/플라스틱삽/ PLASTIC SHOVEL WHITE-14"..				723/사각그물생선망 /ALUMAGUARD BAIT NETS- hoop:15x10"/handle:24"/net depth:4"				724/사각그물생선망 /ALUMAGUARD BAIT NETS- hoop:15x15"/handle:24"/net depth:4"			
															
주문단위	EACH	입수량	1	주문단위	EACH	입수량	1	주문단위	EACH	입수량	1	주문단위	EACH	입수량	1
															
91062005				96363302				96363400				96363401			

GSK	97001391			GSK	96363402			GSK	97001289			GSK	91062004		
85018수산부트레이/SEAFOOD DISPLAY PAN-30 X 10 X 3/4"H -NSF				933/원형생선망/ PEAR-D STYLE HOOP-hoop:15x17"/handle:30"/net depth:24"				93696/알루미늄트레이 /RECTANGULAR RIBBED ALUMINUM MEAT AND SEAFOOD PAN WITH HANDLES -27" x 8 1/2" x 3/4" H				C630-2/수산부긴알루미늄팬트 레이/RECTANGULAR FLAT MEAT&SEAFOOD PAN TRAY- 6.5Wx2Hx30L"/aluminum			
															
주문단위	EACH	입수량	1	주문단위	EACH	입수량	1	주문단위	EACH	입수량	1	주문단위	EACH	입수량	1
															
97001391				96363402				97001289				91062004			

GSK	96313012	GSK	96313010	GSK	96313011	GSK	96363301
RK-2022/생선칼/FISH KNIFE-4"/wood		RK-S121 PCP/굴손질용칼/OYSTER KNIFE-3 3/4"/white		RK-S17/조개칼/CLAM KNIFE-3"/white		플라스틱망치/PLASTIC HAMMER MALLET	
							
주문단위	EACH	입수량	1	주문단위	EACH	입수량	1
							
96313012		96313010		96313011		96363301	
GSK	98246912	GSK	96340127	GSK	96340128	GSK	96340129
SW-SS/수산부미끄럼방지작업발판/304 STAINLESS STEEL STEP STAND-150Lx45Dx30Hcm		0632-0360-16-07/수산부블루팁 디바이더/CLEAR T TYPE DIVIDER WITH BLUE TIP-small/3x18"		0632-0300-16-07/수산부블루팁 디바이더/CLEAR T TYPE DIVIDER WITH BLUE TIP-medium/3x30"(72ea/cs)		0592-0300-16-07/수산부블루팁 디바이더/CLEAR T TYPE DIVIDER WITH BLUE TIP-large/5x30"	
							
주문단위	EACH	입수량	1	주문단위	EACH	입수량	1
							
98246912		96340127		96340128		96340129	

RTC SUPPLY



GSK	95202016	GSK	95202017	GSK	95202273	GSK	95121152								
30%할인레이블/R30% OFF ROUND LABEL— 2" /yellow(1000ea/rl)(25rl/cs)		50%할인레이블/R50% OFF ROUND LABEL— 2" /apricot(1000ea/rl)(25rl/cs)		디자인반찬저울레이블/DESIGN RTC SCALE LABEL— 2.25x3x1.5" /purple(380ea/24rl/cs)		352012/플라스틱샘플링컵 /PLASTIC PORTION CUP— 2oz(2500ea/cs)									
															
주문단위	ROLL	입수량	1000	주문단위	ROLL	입수량	1000	주문단위	CASE	입수량	9120	주문단위	CASE	입수량	2500
															
95202016		95202017		95202273		95121152									
GSK	95121153	GSK	95138028	GSK	95138031	GSK	95138030								
352013/플라스틱샘플링컵뚜껑 /LID FOR PLASTIC PORTION CUP— 2oz(2500ea/cs)		SR868B/블랙전자레인지용냉동사 각용기/BLACK MICROWAVABLE RECT CONTAINER— 8"x6" /28oz/shallow(150ea/cs)		SR-28B/블랙전자레인지용냉동사 각용기/BLACK MICROWAVABLE 2 COMP RECT CONTAINER— 8"x6" /28oz(150ea/cs)		SR8288B/블랙전자레인지용2등분 냉동사각용기/BLACK MICROWAVABLE 2 COMP RECT CONTAINER— 8"x6" /32oz(150ea/cs)									
															
주문단위	CASE	입수량	2500	주문단위	CASE	입수량	150	주문단위	CASE	입수량	150	주문단위	CASE	입수량	150
															
95121153		95138028		95138031		95138030									
GSK	95221116	GSK	95138124	GSK	95138132	GSK	95562200								
NC718B/전자레인지용냉동원형용 기/CONTAINER VERS— 16oz/black/round(150ea/cs)		SR723B/블랙전자레인지용냉동원 형용기/BLACK MICROWAVABLE ROUND CONTAINER— 7" /24oz/shallow(150ea/cs)		SR729B/블랙전자레인지용냉동원 형용기/BLACK MICROWAVABLE ROUND CONTAINER— 7" /24oz/deep(150ea/cs)		SSDY215/나무도시락/DIY WOODEN PASTRY CONTAINER W/ WOODEN LID— 215x120x45mm/8.5x4.8x1.8" /small(100set/cs)									
															
주문단위	CASE	입수량	150	주문단위	CASE	입수량	150	주문단위	CASE	입수량	150	주문단위	CASE	입수량	100
															
95221116		95138124		95138132		95562200									

GSK	95562230	GSK	95562201	GSK	95562231	GSK	95562202
SSDY215/나무도시락이너케이스 /WOODEN PASTRY CONTAINER INNER— 215x120x45mm/8.5x4.8x1.8"/small /black(200ea./cs)		SSDY027/나무도시락 / DIY WOODEN PASTRY CONTAINER W/WOODEN LID— 240x160x50mm/9.5x6.3x2"/large(1 00set./cs)		SSDY027/나무도시락이너케이스 /WOODEN PASTRY CONTAINER INNER— 240x160x50mm/9.5x6.3x2"/large/ black(200ea./cs)		SSDY200/나무도시락 / DIY WOODEN PASTRY CONTAINER W/WOODEN LID— 200x200x50mm/7.9x7.9x2"/square(100set./cs)	
							
주문단위	CASE	입수량	200	주문단위	CASE	입수량	100
							
95562230		95562201		95562231		95562202	
GSK	95562232	IMPERIAL	81000030	IMPERIAL	81000031	GSK	95590104
SSDY200/나무도시락이너케이스 /WOODEN PASTRY CONTAINER INNER— 200x200x50mm/7.9x7.9x2"/square /black(200ea./cs)		F1215NUP/왁스페이퍼/DRY WAX PAPER—12x15"(10lb/5pk/cs)		1215DEL/왁스페이퍼/WET WAX PAPER—12x15"(50ea./cs)		M5/플라스틱위생마스크/PLASTIC MASK/MASCARE—(5ea./pk)	
							
주문단위	CASE	입수량	200	주문단위	CASE	입수량	50
주문단위	CASE	입수량	50	주문단위	CASE	입수량	50
							
95562232		81000030		81000031		95590104	
주문단위	PACK	입수량	5				

MEAT SUPPLY



GSK	95103120	IMPERIAL	85591001	GSK	96340365	GSK	95151107								
C24XH/폴리백/POLY BAG—clear/10x8x24"/17.2LB(500ea/cs)		DLAC50/흡수패드/ABSORBANT PAD—4.75x7"(2600ea/cs)		SW-SS/싸인스탠드/HEAVY DUTY SIGN STAND SNAP OPEN FRAME VERTICAL HORIZONTAL—8.5"x11"/34"to48" tall/black(5ea/cs)		하이퍼포먼스래핑필름/HIGH PERFORMANCE MEAT FILM—4012'x18"/17micron/72gauge									
															
주문단위	CASE	입수량	500	주문단위	CASE	입수량	2600	주문단위	CASE	입수량	5	주문단위	EACH	입수량	1
								95103120		85591001		96340365		95151107	

GSK	95179652	GSK	95179653	GSK	95179654	GSK	95179655								
CSDIV1482/정육부SAVORY디바이더/SAVORY ALWAYS DELICIOUS DIVIDER—small/14"x4—13/16"		정육부SAVORY디바이더/SAVORY ALWAYS DELICIOUS DIVIDER—large/26"x8"		정육부SAVORY디바이더베이스/BASE FOR SAVORY ALWAYS DELICIOUS DIVIDER—small/14"		정육부SAVORY디바이더베이스/BASE FOR SAVORY ALWAYS DELICIOUS DIVIDER—large/26"									
															
주문단위	EACH	입수량	1	주문단위	EACH	입수량	1	주문단위	EACH	입수량	1	주문단위	EACH	입수량	1
								95179652		95179653		95179654		95179655	

GSK	95202274	IMPERIAL	85222022	GSK	95222029	GSK	95222039								
디자인 정육 저울레이블/DESIGN MEAT SCALE LABEL—2.25x3.625x1.5"/green and red(284ea/24rl/cs)		US775/정육부초이스레이블/USDA CHOICE SHIELD LABEL—1—1/4DIA(500ea/rl)		NEWPRIME/USDA프라임스티커/USDA PRIME LABEL—1—1/2x1—1/2"(1000ea/rl)		흑돈 레이블(GBK).BERKSHIRE LABEL,1—3/4"DIA(1000ea/rl)									
															
주문단위	CASE	입수량	6816	주문단위	ROLL	입수량	500	주문단위	ROLL	입수량	1000	주문단위	ROLL	입수량	1000
								95202274		85222022		95222029		95222039	

GSK	95222040	GSK	95222073	GSK	95402445	GSK	95340123								
건조숙성소고기레이블/DRY AGED BEEF LABEL-2X2"(1000ea/rl)		41012/매니저스페셜레이블/MANAGER SPECIAL LABEL,1-1/4" DIA(1000ea/rl)		41369/매운맛레이블/SPICY LABEL-1-1/4" DIA(1000ea/rl)		플라스틱대나무매트(냉장매대용)/PLASTIC BAMBOO MAT-small/400x1000mm/15.75x39.37"									
주문단위	ROLL	입수량	1000	주문단위	ROLL	입수량	1000	주문단위	ROLL	입수량	1000	주문단위	EACH	입수량	1
95222040		95222073		95402445		95340123									
GSK	95340124	GSK	96600015	GSK	95422049	GSK	93061002								
플라스틱대나무매트(냉장매대용)/PLASTIC BAMBOO MAT-large/700x1000mm/27.56x39.37"		DOUGH/스크래퍼/해라/DOUGH SCRAPER		KR-12SS/벽면칼집/KNIFE RACK 12 SLOT STAINLESS STEEL		면장갑/COTTON GLOVES-10*36-white/73031202(360ea/cs)									
주문단위	EACH	입수량	1	주문단위	EACH	입수량	1	주문단위	EACH	입수량	1	주문단위	CASE	입수량	360
95340124		96600015		95422049		93061002									
GSK	95561216	GSK	99599004	GSK	92005002	GSK	95923001								
SNM50010/블루니트릴장갑/BLUE NITRILE DISPOSABLE NITRILE PF GLOVE POWDER FREE-medium(100ea/10pk/cs)		RBC-SW11-10/금해여름장화/SUMMER LONG BOOTS-us10/280cm/navy		(동부용)ELI386012C/헤비클리어쓰레기백/LDPE XTRA HEAVY DUTY GABAGE BAG-38"x58"/1.0mil/55gal/white(100ea/cs)		프리미엄롤페이퍼타월/PREMIUM PAPER TOWEL-11"x 5.5" (6rl/cs)									
주문단위	CASE	입수량	1000	주문단위	EACH	입수량	1	주문단위	CASE	입수량	100	주문단위	CASE	입수량	6
95561216		99599004		92005002		95923001									













ALL SUPPLY DEPARTMENT













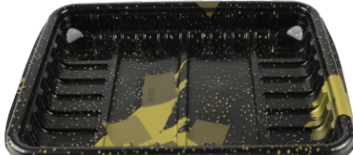
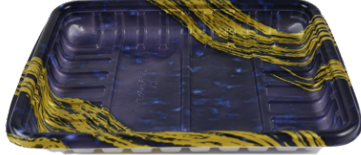





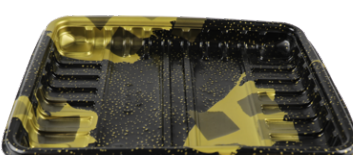
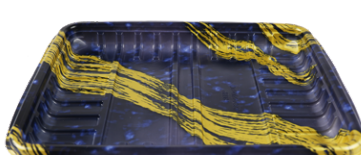

GSK	95562144	GSK	95562145	GSK	95562146	GSK	95562147
GSK10K-BK-27314651/10K 블랙 플라스틱트레이/10K PLASTIC TRAY- 273x146x51mm/blakc(200ea/cs)		GSK10K-CL-27314651/10K 클리어 플라스틱트레이/10K PLASTIC TRAY- 273x146x51mm/clear(200ea/cs)		GSK10K-PK-27314651/10K 핑크 플라스틱트레이/10K PLASTIC TRAY- 273x146x51mm/pink(200ea/cs)		GSK10K-YL-27314651/10K 옐로우 플라스틱트레이/10K PLASTIC TRAY- 273x146x51mm/yellow(200ea/cs)	
							
주문단위	CASE	입수량	200	주문단위	CASE	입수량	200
							
95562144		95562145		95562146		95562147	
GSK	95562138	GSK	95562139	GSK	95562140	GSK	95562141
GSK10S-BK-27313626/10S 블랙 플라스틱트레이/10S PLASTIC TRAY- 273x136x26mm/black(400ea/cs)		GSK10S-BU-27313626/10S 블루 플라스틱트레이/10S PLASTIC TRAY- 273x136x26mm/blue(400ea/cs)		GSK10S-CL-27313626/10S 클리어 플라스틱트레이/10S PLASTIC TRAY- 273x136x26mm/clear(440ea/cs)		GSK10S-PK-27313626/10S 핑크 플라스틱트레이/10S PLASTIC TRAY- 273x136x26mm/pink(400ea/cs)	
							
주문단위	CASE	입수량	400	주문단위	CASE	입수량	400
							
95562138		95562139		95562140		95562141	
GSK	95562142	GSK	95562143	GSK	95562148	GSK	95562149
GSK10S-WT-27313626/10S 화이트 플라스틱트레이/10S PLASTIC TRAY- 273x136x26mm/white(400ea/cs)		GSK10S-YL-27313626/10S 옐로우 플라스틱트레이/10S PLASTIC TRAY- 273x136x26mm/yellow(400ea/cs)		GSK1525S-CL-37520326/1525S 클리어 플라스틱트레이/1525S PLASTIC TRAY- 375x203x26mm/clear(120ea/cs)		GSK1525S-WT-37520326/1525S 화이트 플라스틱트레이/1525S PLASTIC TRAY- 375x203x26mm/white(120ea/cs)	
							
주문단위	CASE	입수량	400	주문단위	CASE	입수량	400
							
95562142		95562143		95562148		95562149	



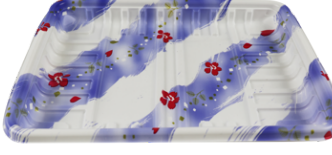
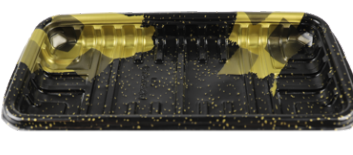
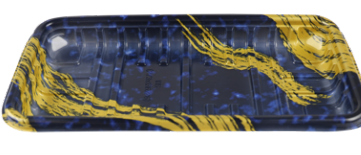

















GSK	95562150	GSK	95562151	GSK	95562152	GSK	95562153
GSK 1525S-YL-37520326/1525S 옐로우플라스틱트레이/1525S PLASTIC TRAY- 375x203x26mm/yellow(120ea/cs)		GSK 16S-CL-31118426/16S 클리 어플라스틱트레이/16S PLASTIC TRAY- 311x184x26mm/clear(260ea/cs)		GSK 16S-PK-31118426/16S 핑크 플라스틱트레이/16S PLASTIC TRAY- 311x184x26mm/pink(260ea/cs)		GSK 16S-YL-31118426/16S 옐로 우플라스틱트레이/16S PLASTIC TRAY- 311x184x26mm/yellow(260ea/cs)	
							
주문단위	CASE	입수량	120	주문단위	CASE	입수량	260
							
95562150		95562151		95562152		95562153	
GSK	95562121	GSK	95562122	GSK	95562123	GSK	95562124
GSK2-BK-21014626/2P 블랙플라 스틱트레이/2P PLASTIC TRAY- 210x146x26mm/black(400ea/cs)		GSK2-BU-21014626/2P 블루플라 스틱트레이/2P PLASTIC TRAY- 210x146x26mm/blue(400ea/cs)		GSK2-CL-21014626/2P 클리어플 라스틱트레이/2P PLASTIC TRAY- 210x146x26mm/clear(480ea/cs)		GSK2-PK-21014626/2P 핑크플라 스틱트레이/2P PLASTIC TRAY- 210x146x26mm/pink(400ea/cs)	
							
주문단위	CASE	입수량	400	주문단위	CASE	입수량	400
							
95562121		95562122		95562123		95562124	
GSK	95562125	GSK	95562154	GSK	95562155	GSK	95562156
GSK2-YL-21014626/2P 옐로우플 라스틱트레이/2P PLASTIC TRAY- 210x146x26mm/yellow(400ea/cs)		GSK20K-CL-30222262/20K 클리 어플라스틱트레이/20K PLASTIC TRAY- 302x222x62mm/clear(100ea/cs)		GSK20K-PK-30222262/20K 핑크 플라스틱트레이/20K PLASTIC TRAY- 302x222x62mm/pink(100ea/cs)		GSK20K-WT-30222262/20K 화이 트플라스틱트레이/20K PLASTIC TRAY- 302x222x62mm/white(100ea/cs)	
							
주문단위	CASE	입수량	400	주문단위	CASE	입수량	100
							
95562125		95562154		95562155		95562156	

























GSK	95562157			GSK	95562158			GSK	95562161			GSK	95562160		
GSK20K-YL-30222262/20K 옐로우플라스틱트레이/20K PLASTIC TRAY-302x222x62mm/yellow(100ea/cs)				GSK4DD-CL/4DD 클리어플라스틱트레이/4DD PLASTIC TRAY-235X184X45mm/clear(100ea/cs)				GSK4DD-PK/4DD 핑크플라스틱트레이/4DD PLASTIC TRAY-235X184X45mm/pink(100ea/cs)				GSK4DD-WT/4DD 화이트플라스틱트레이/4DD PLASTIC TRAY-235X184X45mm/white(100ea/cs)			
															
주문단위	CASE	입수량	100	주문단위	CASE	입수량	100	주문단위	CASE	입수량	100	주문단위	CASE	입수량	100
															
95562157				95562158				95562161				95562160			
GSK	95562159			GSK	95562131			GSK	95562132			GSK	95562133		
GSK4DD-YL/4DD 옐로우플라스틱트레이/4DD PLASTIC TRAY-235X184X45mm/yellow(100ea/cs)				GSK7S-CL-36712626/7S 클리어플라스틱트레이/7S PLASTIC TRAY-367x126x26mm/clear(260ea/cs)				GSK7S-PK-36712626/7S 핑크플라스틱트레이/7S PLASTIC TRAY-367x126x26mm/pink(220ea/cs)				GSK7S-YL-36712626/7S 옐로우플라스틱트레이/7S PLASTIC TRAY-367x126x26mm/yellow(220ea/cs)			
															
주문단위	CASE	입수량	100	주문단위	CASE	입수량	260	주문단위	CASE	입수량	220	주문단위	CASE	입수량	220
															
95562159				95562131				95562132				95562133			
GSK	95562126			GSK	95562127			GSK	95562128			GSK	95562129		
GSKTRO4P-BK-23518429/4P 블랙플라스틱트레이/4P PLASTIC TRAY-235x184x29mm/black(100ea/cs)				GSKTRO4P-CL-23518429/4P 클리어플라스틱트레이/4P PLASTIC TRAY-235x184x29mm/clear(120ea/cs)				GSKTRO4P-PK-23518429/4P 핑크플라스틱트레이/4P PLASTIC TRAY-235x184x29mm/pink(100ea/cs)				GSKTRO4P-WT-23518429/4P 화이트플라스틱트레이/4P PLASTIC TRAY-235x184x29mm/white(100ea/cs)			
															
주문단위	CASE	입수량	100	주문단위	CASE	입수량	120	주문단위	CASE	입수량	100	주문단위	CASE	입수량	100
															
95562126				95562127				95562128				95562129			

GSK	95562130	GSK	95562134	GSK	95562135	GSK	95562136
GSKTRO4P-YL-23518429/4P 엘로우플라스틱트레이/4P PLASTIC TRAY-235x184x29mm/yellow(100ea/cs)		GSKTRO8P-CL-26721026/8P 클리어플라스틱트레이/8P PLASTIC TRAY-267x210x26mm/clear(260ea/cs)		GSKTRO8P-PK-26721026/8P 핑크플라스틱트레이/8P PLASTIC TRAY-267x210x26mm/pink(200ea/cs)		GSKTRO8P-WT-26721026/8P 화이트플라스틱트레이/8P PLASTIC TRAY-267x210x26mm/white(200ea/cs)	
							
주문단위	CASE	입수량	100	주문단위	CASE	입수량	260
							
95562130		95562134		95562135		95562136	
GSK	95562137	GSK	95562206	GSK	95562207	GSK	95562205
GSKTRO8P-YL-26721026/8P 엘로우플라스틱트레이/8P PLASTIC TRAY-267x210x26mm/yellow(200ea/cs)		H-13-1/2구투명트레이/2 COMPARTMENT CLEAR MEDIUM TRAY-13Wx10Lx2.76H"/clear(200ea/cs)		H-16-1/3구투명트레이/3 COMPARTMENT CLEAR MEDIUM TRAY-13Wx10Lx2.76H"/clear(200ea/cs)		H-261705/2구우드트레이/2 COMPARTMENT WOOD SMALL TRAY-258x173Lx50mm/wood(200ea/cs)	
							
주문단위	CASE	입수량	200	주문단위	CASE	입수량	200
							
95562137		95562206		95562207		95562205	
GSK	95562203	GSK	95562204	GSK	95562168	GSK	95562177
H-261705/2구투명트레이/2 COMPARTMENT CLEAR SMALL TRAY-258x173Lx50mm/clear(200ea/cs)		H-261705/2구핑크트레이/2 COMPARTMENT PINK SMALL TRAY-258x173Lx50mm/pink(200ea/cs)		GSK2-BG-21014626/2P블랙앤클드트레이/2P BLACK & GOLD DESIGN PLASTIC TRAY-green tape/210x146x26mm(400ea/cs)		GSK2-BL-21014626/2P남색칭죽트레이/2P NAVY BAMBOO DESIGN PLASTIC TRAY-orange tape/210x146x26mm(400ea/cs)	
							
주문단위	CASE	입수량	200	주문단위	CASE	입수량	200
							
95562203		95562204		95562168		95562177	



















GSK	95562162	GSK	95562173	GSK	95562169	GSK	95562178
GSK2-WD-21014626/2P우드트레이/2P WOOD DESIGN PLASTIC TRAY-red tape/210x146x26mm(400ea./cs)		GSK2-PF-21014626/2P수산트레이/2P FISH DESIGN PLASTIC TRAY-purple tape/210x146x26mm(400ea./cs)		GSKTRO4P-BG-23518429/4P블랙안골드트레이/4P BLACK & GOLD DESIGN PLASTIC TRAY-green tape/235x184x29mm(100ea./cs)		GSKTRO4P-BL-23518429/4P남색칭족트레이/4P NAVY BAMBOO DESIGN PLASTIC TRAY-orange tape/235x184x29mm(100ea./cs)	
							
주문단위	CASE	입수량	400	주문단위	CASE	입수량	400
							
95562162		95562173		95562169		95562178	
GSK	95562163	GSK	95562174	GSK	95562170	GSK	95562179
GSKTRO4P-WD-23518429/4P우드트레이/4P WOOD DESIGN PLASTIC TRAY-red tape/235x184x29mm(100ea./cs)		GSKTRO4P-PF-23518429/4P수산트레이/4P FISH DESIGN PLASTIC TRAY-purple tape/235x184x29mm(100ea./cs)		GSKTRO8P-BG-26721026/8P블랙안골드트레이/8P BLACK & GOLD DESIGN PLASTIC TRAY-green tape/267x210x26mm(200ea./cs)		GSKTRO8P-BL-26721026/8P남색칭족트레이/8P NAVY BAMBOO DESIGN PLASTIC TRAY-orange tape/267x210x26mm(200ea./cs)	
							
주문단위	CASE	입수량	100	주문단위	CASE	입수량	100
							
95562163		95562174		95562170		95562179	
GSK	95562164	GSK	95562175	GSK	95562172	GSK	95562180
GSKTRO8P-WD-26721026/8P우드트레이/8P WOOD DESIGN PLASTIC TRAY-red tape/267x210x26mm(200ea./cs)		GSKTRO8P-PF-26721026/8P수산트레이/8P FISH DESIGN PLASTIC TRAY-purple tape/267x210x26mm(200ea./cs)		GSK10S-BG-27313626/10S블랙안골드트레이/10S BLACK & GOLD DESIGN PLASTIC TRAY-green tape/273x136x26mm(400ea./cs)		GSK10S-BL-27313626/10S남색칭족트레이/10S NAVY BAMBOO DESIGN PLASTIC TRAY-orange tape/273x136x26mm(400ea./cs)	
							
주문단위	CASE	입수량	200	주문단위	CASE	입수량	200
							
95562164		95562175		95562172		95562180	

GSK	95562167	GSK	95562176	GSK	95562171	GSK	95562166
GSK 10S-WD-27313626/10S우드 트레이/10S WOOD DESIGN PLASTIC TRAY-red tape/273x136x26mm(400ea./cs)		GSK 10S-PF-27313626/10S수산트 레이/10S FISH DESIGN PLASTIC TRAY-purple tape/273x136x26mm(400ea./cs)		GSK 16S-BG-31118426/16S블랙앤 골드트레이/16S BLACK & GOLD DESIGN PLASTIC TRAY-green tape/311x184x26mm(220ea./cs)		GSK 16S-WD-31118426/16S우드 트레이/16S WOOD DESIGN PLASTIC TRAY-red tape/311x184x26mm(220ea./cs)	
							
주문단위	CASE	입수량	400	주문단위	CASE	입수량	400
							
95562167		95562176		95562171		95562166	
GSK	95562183	GSK	95562184	GSK	95135008	GSK	95135012
GSK-R1-LWD/R1부채꼴우드트레이/R1 WOOD DESIGN PLASTIC TRAY-28X18(400ea./cs)		GSK-R1-BKG/R1부채꼴블랙앤골드트레이/R1 BLACK AND GOLD DESIGN PLASTIC TRAY-28X18(400ea./cs)		TS8/밀폐사각힌지용기/TAMPER RESIST RECTANGLE CONTAINER-8oz/clear(240ea./cs)		TS12/밀폐사각힌지용기/TAMPER RESIST RECTANGLE CONTAINER-12oz/clear(240ea./cs)	
							
주문단위	CASE	입수량	400	주문단위	CASE	입수량	400
							
95562183		95562184		95135008		95135012	
GSK	95135016	GSK	95135020	GSK	95135024	GSK	95135032
TS16/밀폐사각힌지용기/TAMPER RESIST RECTANGLE CONTAINER-16oz/clear(240ea./cs)		TS20/밀폐사각힌지용기/TAMPER RESIST RECTANGLE CONTAINER-20oz/clear/hinged(200ea./cs)		TS24/밀폐사각힌지용기/TAMPER RESIST RECTANGLE CONTAINER-24oz/clear/hinged(200ea./cs)		TS32/밀폐사각힌지용기/TAMPER RESIST RECTANGLE CONTAINER-32oz/clear/hinged(200ea./cs)	
							
주문단위	CASE	입수량	240	주문단위	CASE	입수량	200
							
85136016		95135020		95135024		95135032	

GSK	95135048	GSK	95135064	IMPERIAL	85136012	IMPERIAL	85136016
TS48/밀폐사각힌지용기/TAMPER RESIST RECTANGLE CONTAINER-48oz/clear/hinged(150ea/cs)		TS64/밀폐사각힌지용기/TAMPER RESIST RECTANGLE CONTAINER-64oz/clear/hinged(150ea/cs)		TS12R/밀폐원형힌지용기(돌출뚜껑)/TAMPER RESISTANT HINGED CONTAINER-12oz(240ea/cs)		TS16R/밀폐 원형힌지용기/TAMPER RESIST ROUND CONTAINER-16OZ-DOME LID(240ea/cs)	
							
주문단위	CASE	입수량	150	주문단위	CASE	입수량	150
							
95135048		95135064		85136012		85136016	
GSK	95136017	IMPERIAL	85136024	IMPERIAL	85136032	IMPERIAL	85135051
TS16RS/밀폐원형힌지용기/TAMPER RESIST ROUND CONTAINER-16OZ-FLAT LID(240ea/cs)		TS24R/밀폐원형힌지용기/TAMPER RESIST ROUND CONTAINER-24OZ-DOME LID(150ea/cs)		TS32R/밀폐원형힌지용기/DOME LID TAMPER RESIST ROUND CONTAINER-32oz(150ea/cs)		TS48RN/밀폐원형힌지용기/DOME LID TAMPER RESIST ROUND CONTAINER-48oz(100ea/cs)	
							
주문단위	CASE	입수량	240	주문단위	CASE	입수량	150
주문단위	CASE	입수량	240	주문단위	CASE	입수량	150
							
95136017		85136024		85136032		85135051	
IMPERIAL	85135068	GSK	95160261	GSK	95160260	GSK	95160219
TS64RN/밀폐원형힌지용기/TAMPER RESIST CLAMSHELL CONTAINER-64OZ-CLEAR/HINGED(100ea/cs)		TZ-0.6 LID/스시용기뚜껑/SUSHI CONTAINER LID-6 3/8 X 3 1/2X1 1/8 "(1500ea/cs)		TZ-0.6 WGF BODY/우드스시용기 몸통/SUSHI CONTAINER BASE-6 3/8 X 3 1/2 X 3/4/wood(1500ea/cs)		TZ-001 BODY/스시용기몸통/SUSHI CONTAINER BASE-8-3/4x3-3/4x7/8"(1400ea/cs)	
							
주문단위	CASE	입수량	100	주문단위	CASE	입수량	1500
주문단위	CASE	입수량	100	주문단위	CASE	입수량	1500
							
95135068		95160261		95160260		95160219	

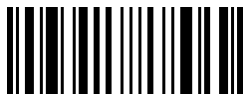
GSK	95160220	GSK	95160262	GSK	95160209	GSK	95160264
TZ-001 LID/스시용기뚜껑/SUSHI CONTAINER LID-8-3/4x3-4/5x1-3/8"(1400ea/cs)		TZ-001 WGF BODY/우드스시용기 몸통/SUSHI CONTAINER BASE-8 3/4 X 3 3/4 X 7/8/wood(1400ea/cs)		TZ-008 LID/스시용기뚜껑/SUSHI CONTAINER LID-6-1/2x4-1/2x1-1/8"(1500ea/cs)		TZ-008 WGF BODY/우드스시용기 몸통/SUSHI CONTAINER BASE-6 1/2 X 4 1/2 X 3/4"/wood(1500ea/cs)	
							
주문단위	CASE	입수량	1400	주문단위	CASE	입수량	1400
							
95160220		95160262		95160209		95160264	
GSK	95160208	GSK	95160210	GSK	95160211	GSK	95160266
TZ-008/스시용기몸통/SUSHI CONTAINER BASE-6-1/2x4-1/2x3/4"(1500ea/cs)		TZ-010 BODY/스시용기몸통 /SUSHI CONTAINER BASE-7-3/8"x5-1/8"x7/8"(1200ea/cs)		TZ-010 LID/스시용기뚜껑/SUSHI CONTAINER LID-7-3/8x5-1/8x1-1/8"(1200ea/cs)		TZ-010 WGF BODY/우드스시용기 몸통/SUSHI CONTAINER BASE-7 3/8 X 5 1/8 X 7/8"/wood(1200ea/cs)	
							
주문단위	CASE	입수량	1500	주문단위	CASE	입수량	1200
							
95160208		95160210		95160211		95160266	
GSK	95160215	GSK	95160268	GSK	95160217	GSK	95160218
TZ-015 BODY/스시용기몸통 /SUSHI CONTAINER BASE-8-1/2x5-3/8x3/4"(1000ea/cs)		TZ-015 WGF BODY/우드스시용기 몸통/SUSHI CONTAINER BASE-8 1/2 X 5 1/4 X 5/8"/wood(1000ea/cs)		TZ-020 BODY/스시용기몸통 /SUSHI CONTAINER BASE-8-1/2x5-3/8x3/4"(800ea/cs)		TZ-020 LID/스시용기 뚜껑/SUSHI CONTAINER LID-9-3/8x5-3/4x1-1/8"(800ea/cs)	
							
주문단위	CASE	입수량	1000	주문단위	CASE	입수량	800
							
95160215		95160268		95160217		95160218	









GSK	95160270	GSK	95160271	GSK	95160221	GSK	95160222
TZ-020 WGF BODY/우드스시용기 몸통/SUSHI CONTAINER BASE-9 1/4 X 5 3/4 X 3/4"/wood(800ea/cs)		TZ-020 WGF LID/우드스시용기뚜껑/SUSHI CONTAINER LID-9 3/8 X 5 3/4 X 1 1/8"/wood(800ea/cs)		TZ-025 BODY-스시용기몸통/SUSHI CONTAINER BASE-10-1/4x7-3/8x7/8"(504ea/cs)		TZ-025 LID/스시용기뚜껑/SUSHI CONTAINER LID-10-1/4x7-3/8x1-3/8"(504ea/cs)	
							
주문단위	CASE	입수량	800	주문단위	CASE	입수량	800
							
95160270		95160271		95160221		95160222	
GSK	95160254	GSK	95160251	GSK	95160253	GSK	95160318
TZ-130/투명블루스시콘테이너콤보/CLEAR BLUE SUSHI CONTAINER COMBO-9-1/2"x4-3/4"x1-1/2",N/A(360ea/cs)		TZ-140/투명블루스시콘테이너콤보/Clear Blue Sushi Container Combo-7-1/2"x7-1/2"x1-1/2"(280ea/CS)		TZ-150/투명블루스시콘테이너콤보/CLEAR BLUE SUSHI CONTAINER COMBO-9.5x7.5x1.5"(200ea/cs)		TZ-305/5등분도시락용기콤보/BENTO BOX COMBO-9-3/8x7-1/2x1-3/8"(252ea/cs)	
							
주문단위	CASE	입수량	360	주문단위	CASE	입수량	280
							
95160254		95160251		95160253		95160318	
GSK	95160317	GSK	95160316	GSK	95160431	GSK	95160430
TZ-306/5등분도시락용기콤보/BENTO BOX COMBO-10-1/2x8-1/8x2",5(200ea/cs)		TZ-307/5등분도시락용기콤보/BENTO BOX COMBO-10-5/8x10-5/8x2",5(100ea/cs)		TZ-807/1등분 도시락 용기 콤보/LUNCH BOX COMBO/6-1/2"x5"x2"(550ea/cs)		TZ-830/1등분 도시락 용기 콤보/LUNCH BOX COMBO-10-1/2x8x2"(200ea/cs)	
							
주문단위	CASE	입수량	200	주문단위	CASE	입수량	100
							
95160317		95160316		95160431		95160430	

GSK	95160231		95160238	GSK	95160230	GSK	95237108								
TZ-W001/흰색스이용기콤보 /SUSHI CONTAINER COMBO WHITE-8-3/4x3- 3/4x7/8"(400ea/cs)		TZ-W008/흰색스이용기콤보 /SUSHI CONTAINER COMBO WHITE-6-1/2"x4- 1/2"x3/4"(440ea/cs)		TZ-W010/흰색스이용기콤보 /SUSHI CONTAINER COMBO WHITE-7-3/8"x5-1/8"x1- 1/8"(400ea/cs)		RD8/원형용기/ROUND CONTIANER- 8oz/Clear(500ea/cs)113031									
															
주문단위	CASE	입수량	400	주문단위	CASE	입수량	440	주문단위	CASE	입수량	400	주문단위	CASE	입수량	500
															
95160231			95160238		95160230		95237108								
IMPERIAL	85137011	GSK	95237116	GSK	95237119	GSK	95151107								
PK12S/반투명원형용기/PLASTIC ROUND CONTAINER- 12oz(500ea/cs)		RD16/원형용기,ROUND CONTIANER-16oz clear(500ea/cs)113036		113049/원형용기뚜껑/LID FOR ROUND CONTAINER- 8/12/16/32oz/Clear(500ea/cs)		하이퍼포먼스래핑필름/HIGH PERFORMANCE MEAT FILM- 4012'x18"/17micron/72gauge									
															
주문단위	CASE	입수량	500	주문단위	CASE	입수량	500	주문단위	CASE	입수량	500	주문단위	EACH	입수량	1
															
85137011			95237116		95237119		95151107								
GSK	96304209	GSK	95421103												
HS625A/래핑기계/HEAT SEAL SINGLE 18" ALEX MOUNTED TABLE TOP WRAPPING MACHINE-115V, 748W		TC615B/615래핑기계덮개/HEAT SEAL GENUINE PARTS NON-STICK WRAPPING MACHINE COVER- 6Wx15H"													
															
주문단위	EACH	입수량	1	주문단위	EACH	입수량	1								
															
96304209			95421103												

























OFFICE SUPPLY

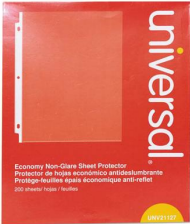











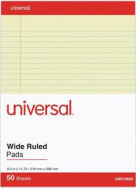













W.B.	97000883	W.B.	97002303	W.B.	97002670	W.B.	97002746
OS//CPC560191/가짜돈판독기 펜/CONTROL GROUP COUNTERFEIT BILL DETECTOR PENS-(3ea/pk)		OS//BICGSMG11BK/블랙볼펜 /BIC Ultra Round Stic Grip Ballpoint Stick Pen- Black Ink-Medium(1...		OS//SAN80001/블랙마커 /EXPO DRY ERASE MARKER BLACK)		OS//BICBL11YW/엘로하이라이터 /BIC Brite Liner Highlighter, Chisel Tip- Fluorescent Yellow Ink(12/DOZEN)	
							
주문단위	PACK	입수량	3	주문단위	CASE	입수량	12
							
97000883		97002303		97002670		97002746	











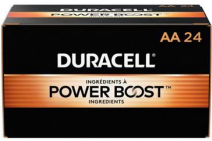







W.B.	97002779	W.B.	97005417	W.B.	97002241	W.B.	97002296
OS//SAN25026/그린샤피 /Sharpie Accent Tank Style Highlighter-Chisel Tip- Fluorescent Green-(12/Pk)		OS//BICMP11/연필/BIC MECHANICAL PENCIL, HB- #2- CLEAR BARREL, REFILLABLE- DOZEN)		OS//BICWOTAP10/와이트아웃 /BIC WITE OUT EZ CORRECT CORRECTION TAPE NON REFILLABLE-1/6" x 472"...		OS//PENZEH10BP3K6/펜텔지우 개/Pentel Hi-Polymer Block Eraser- (3/Pack))	
							
주문단위	PACK	입수량	12	주문단위	CASE	입수량	10
							
97002779		97005417		97002241		97002296	

W.B.	97009827	W.B.	97002238	W.B.	97002634	W.B.	97002192
OS//COS098373/보이드스탬프 /2000 PLUS GREEN LINE MESSAGE STAMP-VOID- 1 1/2X 9/16- BLUE)		OS//SW35108/스테이플러심 /SWINGLINE S.F. 1 STANDARD ECONOMY CHISEL POINT 210 FULL STRIP ST...		OS//MMMC38BK/테이프디스펜 서/SCOTCH DESKTOP TAPE DISPENSER-1" core/black/(1ea))		OS//MMM600K12/스카치테이프 /SCOTCH TRANSPARENT TAP- 3/4" x 1000" 1" core/ clear/(12ea/pk))	
							
주문단위	EACH	입수량	1	주문단위	CASE	입수량	5000
							
97009827		97002238		97002634		97002192	

W.B.	97002874	W.B.	97002308	W.B.	97002125	W.B.	97002930								
OS//UNV10220/라쥐클립 /UNIVERSAL LARGE BINDER CLIPS STELL WIRE-1" capacity 2" wide/black/silver/(cs)		OS//ACC72100/라쥐바인더클립 /ACCO LARGE BINDER CLIPS STELL WIRE-1 1/16" capacity 2"w/black/silver/(1cs)		OS//UNV10200/스몰바인더클립 /UNIVERSAL SMALL BINDER CLIPS STELL WIRE-3/8" capacity 3/4" wide/ black/silver/(1cs)		OS//(SWI44401S/ 스테이플러/ Swingline Commercial Desk Stapler/ 20-Sheet Capacity- Black)									
															
주문단위	CASE	입수량	12	주문단위	CASE	입수량	12	주문단위	CASE	입수량	12	주문단위	EACH	입수량	1
															
W.B.	97001022	W.B.	97002448	W.B.	97002009	W.B.	97005049								
OS//(CSOMS80B/계산기/CASIO MS-80B TAX ABD CURRENCY CALCULATOR-(1ea))		OS//(UNV31750/레터오픈너 /UNIVERSAL LETTER OPENER-9"- SILVER)		OS//(WBM21200/복사용지 /FLAGSHIP™ COPY PAPER 92 BRIGHT-20 LB/8 1/2" x 11"/(1cs))		OS//SWI74037/홀펀치/Swingline 10-Sheet Precision Pro Desktop Two- and Three-Hole Punch- 9/32" Holes									
															
주문단위	EACH	입수량	1	주문단위	EACH	입수량	1	주문단위	PACK	입수량	500	주문단위	EACH	입수량	1
															
	97004147	W.B.	97011286	W.B.	97006430	W.B.	97001033								
OS//(UNV21127/서류프로텍터시 트/Universal Top-Load Poly Sheet Protectors, Nonglare, Economy-...		OS//(WBM35267/부라운서류봉 투/W.B. Mason Co. Kraft Clasp Envelope-10 x 13- Brown Kraft (100/...		OS//(UNV36003/유니버설봉투 /Universal One Peel Seal Strip Business Envelope-#10- White- 500/...		OS//(MMM4010/더블사이드스카 치테이프/ Scotch Double-Sided Mounting Tape, Industrial Strength...									
															
주문단위	CASE	입수량	200	주문단위	CASE	입수량	100	주문단위	CASE	입수량	500	주문단위	EACH	입수량	1
															
	97004147		97011286		97006430		97001033								























W.B.	99771158	W.B.	97001069	W.B.	97002217	GSK	97005061								
OS// (AVE00166/글루스틱/ Avery Permanent Glue Stics—Clear Application—26 oz)		OS// (EPIE1322/엘머글루/Elmer's Glue—All White Glue—Repositionable— 4 oz)		OS// ACC72020/중간사이즈바인 더클립/ACCO SMALL BINDER CLIPS STEEL WIRE—5/16" Cap 3/4"W/black/silver/(1cs)		RCP611200YW/미끄럼방지싸인판 /Rubbermaid Commercial Multilingual "Caution" Floor Sign Plastic—11 x 1 1/2 x 26—Bright Yellow									
															
주문단위	EACH	입수량	1	주문단위	CASE	입수량	12	주문단위	EACH	입수량	1				
															
W.B.	97006570	W.B.	97004318	W.B.	97003020	W.B.	97003083								
JOJ100563500/밴드에이드/ Plastic Adhesive Bandages—60/Box		LIL58030/에드빌/Advil Single-Dose Ibuprofen Tablets Refill Packs— Two— Packs— 30 Packets/Box		PFX15213ASST/칼라폴더 Pendaflex Colored File Folders—1/3 Cut Top Tab— Letter— Assorted Colors— 100/Box		MMMTP3854100/ 레터사이즈라미 네이트파우치/ Scotch Letter Size Thermal Laminating Pouches—11 1/2 x 9—(100 per Pack)									
															
주문단위	CASE	입수량	60	주문단위	CASE	입수량	30	주문단위	CASE	입수량	100	주문단위	PACK	입수량	100
															
W.B.	97004108	W.B.	97010756	W.B.	97000868	W.B.	97004069								
MMM653AN/포스트잇/Post-it Notes— 1—1/2 x 2, Neon Colors—2 100—Sheet Pads/Pack		MMM6549B/스티키노트패드 /Highland Sticky Note Pads—3 x 3— Assorted—100 Sheets		SMD10330/마닐라폴더/SMEAD FILE FOLDERS 1/3 CUT ASSORTED ONE PLY TOP TAB LETTER MANILA—(100ea/cs)		MMM684ARR2/포스트잇에로우표시 /Post-it Flags Arrow 1/2" Flags, Five Assorted Bright Colors— 20/Color—100/Pack									
															
주문단위	PACK	입수량	12	주문단위	PACK	입수량	12	주문단위	CASE	입수량	100	주문단위	PACK	입수량	100
															



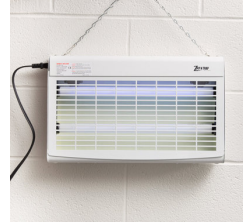

W.B.	97002678	W.B.	97001565	W.B.	97001566	W.B.	97005775								
UNV10630/노트패드/Universal Perforated Edge Writing Pad Legal/Margin Rule- Letter- Canary- 50-Sheet Dozen		IVR72200/익스텐션코드 /INNOVERA INDOOR EXTENSION CORD-100FT-ORANGE		TRPTLP404/익스텐션코드/TRIPP LITE BYE POWER STRIP 4 OUTLET 4'		FEL99026/15피트아웃렛/SIX-OUTLET POWER STRIP/120V/15FT CORD									
															
주문단위	CASE	입수량	12	주문단위	EACH	입수량	1	주문단위	EACH	입수량	1	주문단위	EACH	입수량	1
															
W.B.	97001586	W.B.	97001612	W.B.	97001615	W.B.	97001538								
FAO440/퍼스트에이드키트 /PhysiciansCare Outdoor First Aid Kit, For Up to 25 People, 204 Pieces/Kit		IVR73306/ 멀티탭 / Innovera Six-Outlet Power Strip, 6 ft Cord, 1.94 x 10.19 x 1.19, Ivory		WBM46200/노트패드/WB MASON WRITING PAD-5"X8" 12 PAD -50 SHEETS		WBMTD2/테이프디스펜서/Tape Logic Work Horse Carton Sealing Tape Dispenser, 2", Blue/White									
															
주문단위	EACH	입수량	1	주문단위	EACH	입수량	1	주문단위	CASE	입수량	12	주문단위	EACH	입수량	1
															
W.B.	97002757	W.B.	97010185	W.B.	97001602	W.B.	97003135								
CLOR30208/크로락스와이프 /CLORAX DISINFECTING WIPES VALUE PACK-3/PACK		(TRPPS6) 멀티탭 / POWER STRIP, 6 OUTLETS, 1 3/4X9 1/2X1/4, 4FT CORD, GRAY		FLFG0993/의자/Flash Furniture Hercules Series 24/7 Intensive Use Big & Tall, Black Mesh Executive Ergonomic Office Chair		FEL99598/익스텐션코드/Fellowes Indoor/Outdoor Heavy-Duty 3-Prong Plug Extension Cord-1-Outlet- 50ft- Orange									
															
주문단위	PACK	입수량	3	주문단위	EACH	입수량	1	주문단위	EACH	입수량	1	주문단위	EACH	입수량	1
															









W.B.	97005031	W.B.	97001420	W.B.	97012700	W.B.	97001447								
DURMN1500B24 / 더블에이전전지 / Duracell CopperTop Alkaline Batteries with Duralock Power Preserve Technology - AA(24/Box)		DURNLAAA4BCD / 트리플A배터리 / Duracell Rechargeable AAA Batteries-4/Pack		CLO31547 / 크로락스와입 / CLORAX DISINFECTIN WIPES-700/CS		SWI9312 / 종이절단기(트리머) / SWINGLING CLASSICCUT LITE PAPER-13 X 19 1/2"									
															
주문단위	CASE	입수량	24	주문단위	PACK	입수량	4	주문단위	CASE	입수량	700	주문단위	EACH	입수량	1
															
W.B.	97001324	W.B.	97001533	W.B.	97001559	W.B.	97002014								
COC4114BK / 캐서대밀쓰레기통 / TRASH WASTE BASKET-41 1/4QT -15 X 11.5 X 19.75- BLACK		GOR108084 / 고릴라테이프 / BLACK-50yard		SAN32003 / 샤프마커 / SHARPIE TWIN PERMANENT MARKER-BLUE-12/DZ		OS // (AVE24148 / 마커 / Marks-A-Lot Permanent Marker-Jumbo Chisel Tip- Black-(12/CASE))									
															
주문단위	EACH	입수량	1	주문단위	ROLL	입수량	1	주문단위	CASE	입수량	12	주문단위	CASE	입수량	12
															
W.B.	97000871	W.B.	97001714												
LOG920007897 / 무선키보드와마우스 / Logitech MK235 Wireless Keyboard and Mouse		(BLKF8E262BLK) 마우스패드 / Belkin WaveRest Gel Mouse Pad													
															
주문단위	EACH	입수량	1	주문단위	EACH	입수량	1								
															

EQUIPMENT



GSK	98234901	GSK	85404012	GSK	98100909	GSK	95124161
EM720CPL-PMB/전자레인지 /COMFEE' COUNTERTOP MICROWAVE OVEN- black/17.3"x13"x10.2"/0.7cu.ft./11 0v/700w		RT22/워키토키/RETEVIS RT22 WALKIE TALKIES TWO WAY RADIO -BLACK-(10ea./pk)		6000BR/핸트트럭/TWIN-HANDLE HAND TRUCK-500lbs/nose plate 18" wide/wheel type 8"x1.5" moldon rubber/50"Hx18"Wx18"D		H-2661/맥라이너핸트트럭 /MAGLINER STANDDARD ALUMINIUM HAND TRUCK- 14 X 7 1/2" 8" SOLID RUBBER	
							
주문단위	EACH	입수량	1	주문단위	PACK	입수량	10
							
98234901		85404012		98100909		95124161	
GSK	98205933	GSK	98205935	GSK	97999946	GSK	98211911
H-3377/핸트트럭프레임익스텐션 /FRAME EXTENSION FOR ALUMINIUM HAND TRUCKS for H- 2661-60"		H-1208/핸트트럭노즈익스텐션 /NOSE EXTENSION FOR ALUMINIUM HAND TRUCKS for H-2661-30"		H-1825G/유보트/U-BOAT PLATFORM TRUCK-16 X 60"- GREEN		HE-1660/리틀자이언트유보트 /LITTLE GIANT HIGH END PLATFORM TRUCK- 16Wx60Lx59H"/2000lbs	
							
주문단위	EACH	입수량	1	주문단위	EACH	입수량	1
							
98205933		98205935		97999946		98211911	
GSK	98246910	GSK	98246911	GSK	98100811	GSK	96303840
SW-2FL/2단접이식사다리/SW H-MART LOGO 2 STEP FOLDING LADDER-77"Hx45"Wx54.5mm"D		SW-3FL/3단접이식사다리/SW H-MART LOGO 3 STEP FOLDING LADDER-102"Hx45"Wx72mm"D		PTH50-027-48-1C/크라운 팔렛 잭/CROWN PALLET TRUCK		605GT30W/뉴파리잡는기계글루타 입/Zap N Trap White Insect Light Trap with Glue Board - 30W	
							
주문단위	EACH	입수량	1	주문단위	EACH	입수량	1
							
98246910		98246911		98100811		96303840	

GSK	98108077	GSK	96324558	GSK	96324559	GSK	98210912
B1918439/벌크무버카트바스켓포함 / PRAIRIE VIEW BULK MOVER-LUGCT1BK4-NBT-32-3/4"L x 21-1/4"W x 36"H		109CARTBLGBL/3단카트/CHOICE UTILITY CART W/3 SHELVES-42Lx20Wx38H"/blue		109CARTBLGBK/3단카트/CHOICE UTILITY CART W/3 SHELVES-42Lx20Wx38H"/black		109CARTBLGGY/3단카트/CHOICE UTILITY CART W/3 SHELVES-42Lx20Wx38H"/gray	
							
주문단위	EACH	입수량	1	주문단위	EACH	입수량	1
							
98108077		96324558		96324559		98210912	
GSK	98001112	GSK	98254903	GSK	98100239	ACTION	91000098
109CARTBUSBK/3단카트/CHOICE UTILITY CART W/3 SHELVES-32Lx16Wx38H"/black		NEW로고크라우드베리어/NEW STACKABLE BARRIER with H-MART LOGO BELT+WHEEL-red/dia 63mm pole/350mm base/6.7ftx2"		96134BH/2단카트/NEW AGE 700LB PLATFORM TRUCK BUSSING UTILITY CART METAL-41.5"(L)x46"(W)x19"(H)		ESCA-SCDGM33/디지털저울 /SCDGM33 33 LBS M-SERIES DIGITAL PORTION CONTROL SCALE-12"x10.25"x4.15"/SILVER	
							
주문단위	EACH	입수량	1	주문단위	EACH	입수량	1
							
98001112		98254903		98100239		91000098	
GSK	98246900	GSK	98246901	GSK	97002463	GSK	97001219
JWY-01/와이어빈/WIRE BIN-small/chrome/17.6"x17.6"x30"/dia 5.8mm(3ea/cs)		JWY-02/와이어빈/WIRE BIN-medium/chrome/24"x28"x32"/dia 5.8mm(2ea/cs)		H-4808GR/유라인더블티어락커 /U LINE DOUBLE TIER LOCKERS-36"x12"x72"		H-5549/유라인락커/ULINE THREE TIER LOCKERS-36" WIDE-GR-36Wx18Dx72H"	
							
주문단위	CASE	입수량	3	주문단위	CASE	입수량	2
주문단위	EACH	입수량	1	주문단위	EACH	입수량	1
							
98246900		98246901		97002463		97001219	

GSK	98205940			GSK	97003211			GSK	97003377			GSK	98201901		
H-7586T/유라인락커/ULINE THREE TIER LOCKERS UNASSEMBLED- 45Wx18Dx72H"/Tan				H-8343/유라인포티어락커/ULINE FOUR TIER LOCKERS-36"x18"x72"				H-1393AGR/락커/INDUSTRIAL LOCKER SIX TIERS-36"x18"x72"				1356M/뉴에이지유니버설6단카트 /NEW AGE UNIVERSAL 5 SHELVES CART			
															
주문단위	EACH	입수량	1	주문단위	EACH	입수량	1	주문단위	EACH	입수량	1	주문단위	EACH	입수량	1
															

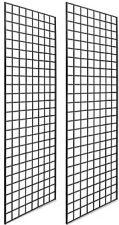
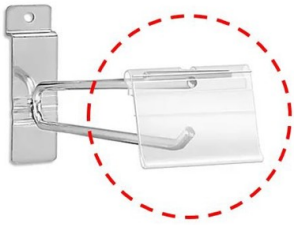
GSK	98215690			GSK	98215902		
KL-GRWL-R8014/GRID WALL- 4'x4'/RAL8014				KL-SWPT/스윙프라이스타그 /SWING PRICE TAG FOR DOUBLE LINE HOOK- transparent/40x80mm/1.6"x3.2" (10 0ea/pk)			
							
주문단위	EACH	입수량	1	주문단위	PACK	입수량	100
